



# xpertials

baño

**CATÁLOGO 2025**  
*CATALOGUE 2025*

**ILUMINAMOS TU BAÑO**  
*WE BRING  
LIGHTING MOODS  
TO YOUR BATHROOM*

**xpertials**  
baño

# Índice / Index

## ESPEJOS / MIRRORS

|                        |     |
|------------------------|-----|
| Aitana.....            | 22  |
| Alba.....              | 136 |
| Alice.....             | 30  |
| Amira.....             | 52  |
| Anaís.....             | 18  |
| Anouk.....             | 16  |
| Arán.....              | 38  |
| Astro.....             | 42  |
| Basic.....             | 148 |
| Belice.....            | 154 |
| Bera Rectangular.....  | 56  |
| Bera Redondo.....      | 54  |
| Beth Rectangular.....  | 114 |
| Beth Redondo.....      | 110 |
| Black.....             | 140 |
| Cápsula.....           | 152 |
| Celia Cápsula.....     | 78  |
| Celia Rectangular..... | 76  |
| Celia Redondo.....     | 74  |
| Cies Up&Down.....      | 126 |
| Dalia Redondo.....     | 58  |
| Dalia Rectangular..... | 60  |
| Daphne.....            | 134 |

|                        |     |
|------------------------|-----|
| Duved.....             | 122 |
| Eco Oneled.....        | 130 |
| Eco Twoled.....        | 132 |
| Emin.....              | 34  |
| Emma Cápsula.....      | 84  |
| Emma Rectangular.....  | 82  |
| Emma Redondo.....      | 80  |
| Eyra.....              | 24  |
| Gredos.....            | 36  |
| Iris.....              | 118 |
| Jaspe.....             | 162 |
| Jaspe Led.....         | 44  |
| Katia.....             | 20  |
| Kea Cápsula.....       | 90  |
| Kea Rectangular.....   | 88  |
| Kea Redondo.....       | 86  |
| Khan.....              | 48  |
| Klara Cápsula.....     | 108 |
| Klara Rectangular..... | 106 |
| Klara Redondo.....     | 104 |
| Lisbeth.....           | 28  |
| Lua.....               | 138 |
| Lumix.....             | 120 |
| Menorca.....           | 156 |

|                          |     |
|--------------------------|-----|
| Mireia.....              | 160 |
| Mireia Led.....          | 46  |
| Moncada.....             | 144 |
| Noa Rectangular.....     | 102 |
| Noa Redondo.....         | 100 |
| Noir.....                | 142 |
| Nuria.....               | 128 |
| Osna.....                | 32  |
| Paris.....               | 40  |
| Redondo.....             | 150 |
| Romo.....                | 158 |
| Salma Cápsula.....       | 72  |
| Salma Rectangular.....   | 70  |
| Salma Redondo.....       | 68  |
| Shira.....               | 50  |
| Siro Cápsula.....        | 66  |
| Siro Rectangular.....    | 64  |
| Siro Redondo.....        | 62  |
| Stone.....               | 124 |
| Urano.....               | 116 |
| Valencia.....            | 146 |
| Yves.....                | 26  |
| Zoe Rectangular.....     | 94  |
| Zoe Rectangular Led..... | 98  |

|                      |    |
|----------------------|----|
| Zoe Redondo.....     | 92 |
| Zoe Redondo Led..... | 96 |

## APLIQUES / SPOTLIGHTS

|             |     |
|-------------|-----|
| Altair..... | 164 |
| Drop.....   | 166 |
| Round.....  | 168 |

## ESPEJOS HOME / HOME MIRRORS

|                  |     |
|------------------|-----|
| Aitana Home..... | 172 |
| Shira Home.....  | 174 |
| Anaís Home.....  | 176 |

## MONTAJES / CONSTRUCTION

|       |     |
|-------|-----|
| ..... | 178 |
|-------|-----|

## ICONOGRAFIA/KEY TO SYMBOLS

|       |     |
|-------|-----|
| ..... | 182 |
|-------|-----|



## ¿Quienes somos?

Xpertials, es una empresa fundada en Enero del año 2014 con un equipo ya especializado en el sector del baño, y que hoy en día es una de las empresas más notables en la fabricación y distribución de espejos con iluminación led y focos led para el baño. Nuestras instalaciones están ubicadas en Rafelbunyol (Valencia) España. Disponemos de 3 modernas instalaciones de más 4.100 m<sup>2</sup> con los recursos necesarios para dar soluciones a las necesidades más exigentes.



## Who are we?

*Founded in 2014 and based in Rafelbunyol (Valencia-Spain), Xpertials counts with a dedicated specialized team, nowadays, its counted among one of the notable suppliers that manufactures and distributes Led mirrors and Led spotlights for the bathroom. Xpertials' facilities covers an area of more than 4.100 square meters, consisted of offices, assembly line together with specialized, advanced manufacturing technique and equipment for trial and support production.*



# Nuestro Mercado

Somos una empresa especializada en la producción y distribución de Espejos con iluminación Led y Focos Led para GSB e Industriales del Mueble de Baño. Nuestra red de distribución y transporte, nos hace muy competitivos tanto a nivel nacional como europeo. Estamos presentes en más de 22 países.

## *Our Market*

*We specialize in Led mirrors and Led spotlights production and distribution for DIY and bathroom furniture manufacturers.  
We intend to build on the wealth of our range and the power of our distribution network and transport to increase market share at the european level as well as at the national level.  
We have a presence in 22 countries.*



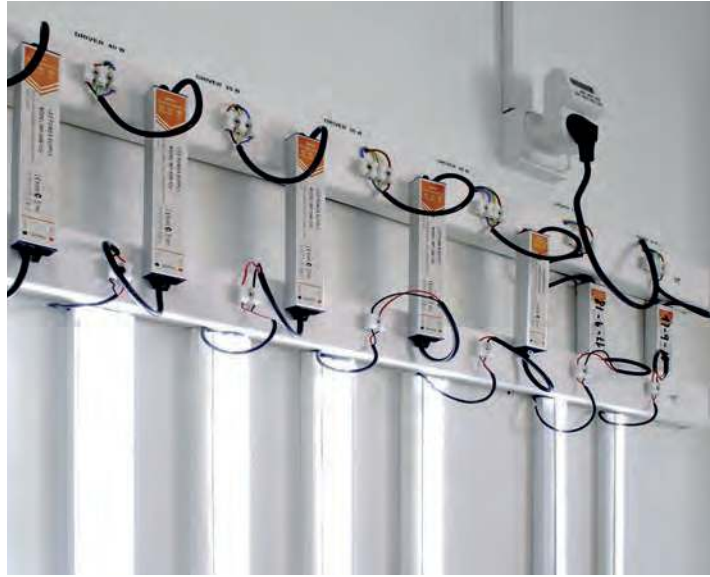

## Equipo especializado

### Con mas de 35 años de experiencia en el sector.

En nuestras instalaciones disponemos de un departamento de I+D de producto para investigar la incorporación de las innovaciones tecnológicas a los espejos de baño, y de un departamento de Marketing, para analizar tendencias y necesidades y aplicarlo al desarrollo de nuestro producto. Todo esto nos permite tener flexibilidad y polivalencia para adaptarnos a las necesidades de nuestros clientes, dentro de un marco de la búsqueda de la excelencia y la calidad en nuestros productos.



## Specialized team

### With over 35 years of experience within the bathroom sector

*Our company has a well equipped I+D Department to investigate to incorporate technological innovations to Led Mirrors, and a Marketing Department to study new trends, strategies and requirements in order to implement on our product development. It all allows flexibility and versality to adapt to our customers requirements, pursuing excellence, quality and strive for total customer satisfaction.*

# Producto

Nuestra empresa dispone de la tecnología más avanzada, junto con un equipo humano especializado en el sector, que nos proporciona una alta capacidad productiva puesta al servicio del cliente. Ser fabricantes nos permite adaptarnos a cualquier necesidad que nuestros clientes nos soliciten, con una esmerada calidad de producto y en constante desarrollo de las nuevas tecnologías del Mercado. Gracias a nuestra experiencia y polivalencia al ser fabricantes nos permite ofrecer espejos a medida diferenciándonos de esta forma de otros proveedores.

## Product

*Xpertials has the most modern technology, together a highly specialized staff that provides a high production capacity to put them at the customer's service. As manufacturers, we adapt to our customer needs, we have become a reliable strategic partner of many companies. Thanks to our experience and multiple skills as manufacturers, we can offer customized mirrors (in size, design, features... etc) differentiating us from other suppliers.*



# Medio Ambiente

Consumimos energía eléctrica solo y exclusivamente de instalaciones de generación a partir de fuentes renovables.  
Contratación de empresas externas para el reciclaje de todos nuestros sobrantes de materias primas o productos deteriorados.  
Contratación del sistema de gestión de residuos (eco-embalaje) ECOEMBES.

## Environment

We use electrical energy solely and exclusively from renewable sources.  
External service contracts for recycling excess raw materials or damaged products.  
Integration to the system of waste managements (eco- packaging ) ECOEMBES





# Anouk

| CM     | W LED | LUMENS | W ANTIVAHO/Opción<br>W DEFOGGER/Optional |
|--------|-------|--------|--|
| 60X80  | 19.84 | 1860   | 16                                       |
| 80X80  | 23.04 | 2160   | 30                                       |
| 100x80 | 26.24 | 2460   | 46                                       |
| 120x80 | 29.44 | 2760   | 70                                       |
| 140x80 | 32.64 | 3060   | 70                                       |



Producto disponible a medida  
Measures available on request

Opciones / Options :

|  |  |  |  |
|--|--|--|--|
|  |  |  |  |
|  |  |  |  |
|  |  |  |  |

Ficha técnica / Technical sheet :

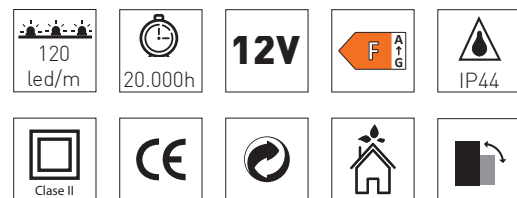

Acabado acero / Steel finish



Acabado negro / Black finish

Montaje 1 / Construction 1



\* Espejo Foto / Photo Mirror: Anouk 120x80 cm / 5500°K

# Anais

| CM     | W LED | LUMENS | W ANTIVAHU/Opción<br>W DEFOGGER/Optional |
|--------|-------|--------|--|
| 60X80  | 19.84 | 1860   | 16                                       |
| 80X80  | 23.04 | 2160   | 30                                       |
| 100X80 | 26.20 | 2460   | 46                                       |
| 120X80 | 29.44 | 2760   | 70                                       |
| 140X80 | 32.64 | 3060   | 70                                       |



Producto disponible a medida  
Measures available on request

Opciones / Options :

|  |  |  |  |
|--|--|--|--|
|  |  |  |  |
|  |  |  |  |
|  |  |  |  |

Ficha técnica / Technical sheet :

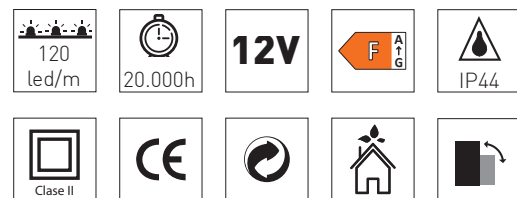

Acabado acero / Steel finish



Acabado negro / Black finish

Montaje 1 / Construction 1



\* Espejo Foto / Photo Mirror: Anais 80x80 cm / 5500°k

# Katia

| CM     | W LED | LUMENS | W ANTIVAHÓ/Opción<br>W DEFOGGER/Optional |
|--------|-------|--------|--|
| 60x70  | 20.20 | 1890   | 16                                       |
| 80x70  | 23.36 | 2190   | 30                                       |
| 100x70 | 26.56 | 2490   | 46                                       |
| 120x70 | 29.76 | 2790   | 70                                       |



Producto disponible a medida  
Measures available on request

Opciones / Options :

|  |  |  |  |
|--|--|--|--|
|  |  |  |  |
|  |  |  |  |
|  |  |  |  |

Ficha técnica / Technical sheet :

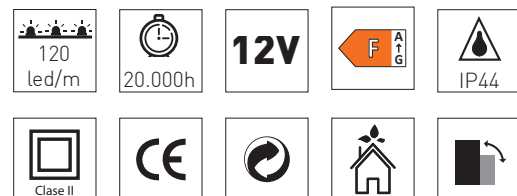

Montaje 9 / Construction 9

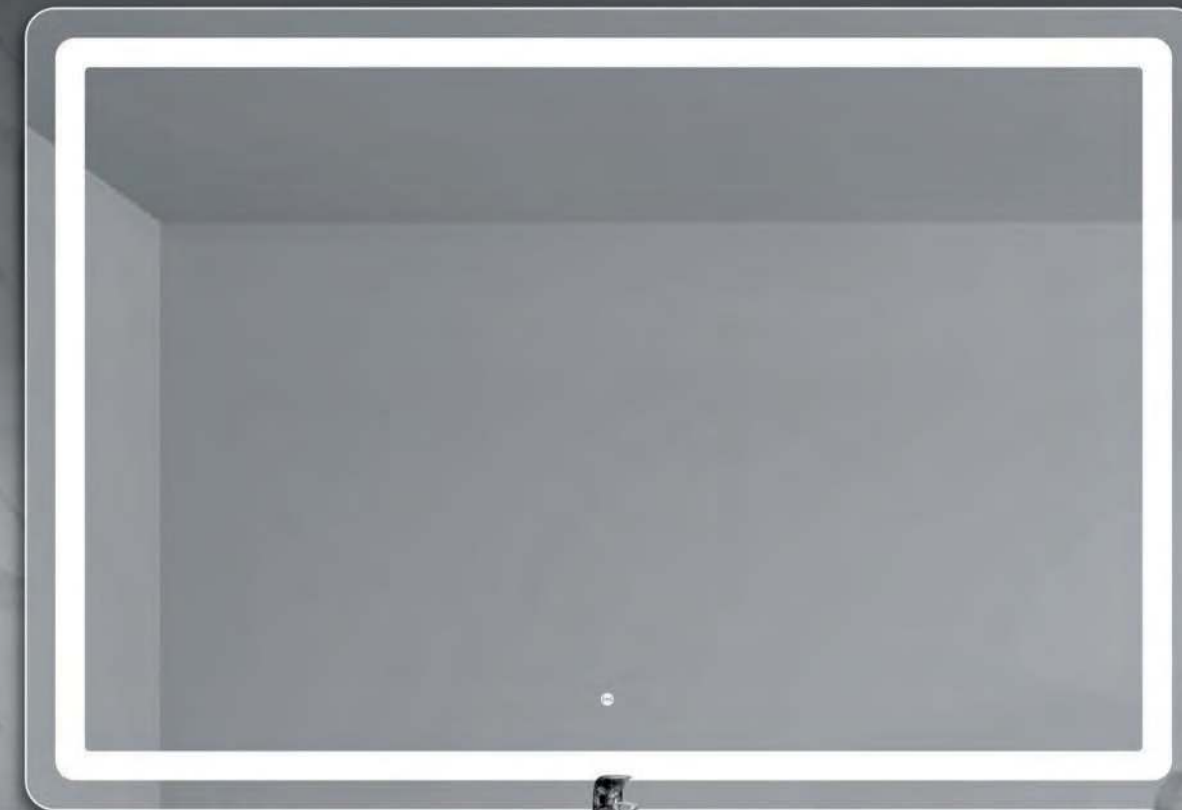

\* Espejo Foto / Photo Mirror: Katia 120x80 cm / 5500°k

# Aitana

| CM     | W LED | LUMENS | W ANTIVAH/Opción<br>W DEFOGGER/Optional |
|--------|-------|--------|---|
| 60x80  | 21.76 | 2040   | 16                                      |
| 80x80  | 24.96 | 2340   | 30                                      |
| 100x80 | 28.16 | 2640   | 46                                      |
| 120x80 | 31.36 | 2940   | 70                                      |
| 140x80 | 34.56 | 3240   | 70                                      |



Producto disponible a medida  
Measures available on request

Opciones / Options :

|  |  |  |  |
|--|--|--|--|
|  |  |  |  |
|  |  |  |  |
|  |  |  |  |

Ficha técnica / Technical sheet :

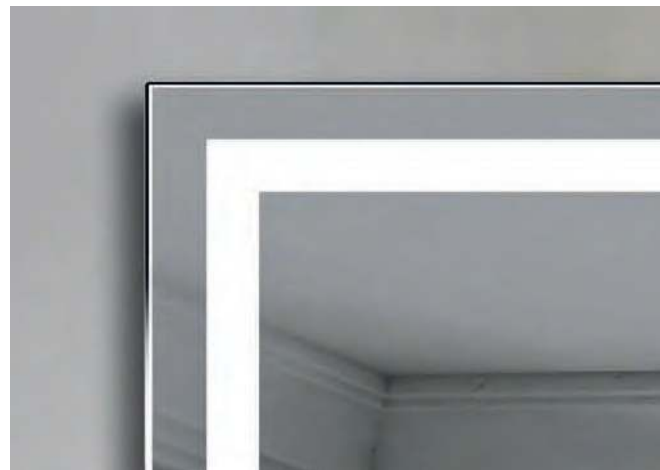
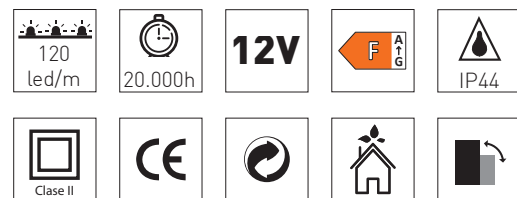

Montaje 9 / Construction 9



\* Espejo Foto / Photo Mirror: Aitana 80x80 cm / 5500°k

# Eyra + sensor touch

| CM     | W LED | LUMENS | W ANTIVAH/Opción<br>W DEFOGGER/Optional |
|--------|-------|--------|---|
| 60x80  | 19.84 | 1860   | 16                                      |
| 80x80  | 23.04 | 2160   | 30                                      |
| 100x80 | 26.24 | 24.60  | 46                                      |
| 120x80 | 29.44 | 2760   | 70                                      |
| 140 80 | 32.64 | 3060   | 70                                      |



Opciones / Options :

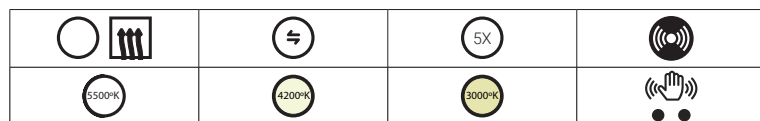

Ficha técnica / Technical sheet :

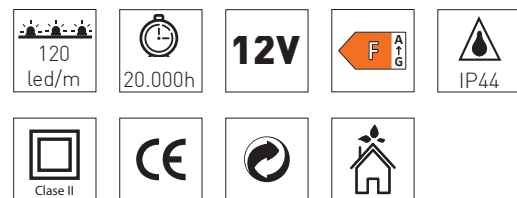

Acabado acero / Steel finish



Acabado negro / Black finish

Montaje 1 / Construction 1



\* Espejo Foto / Photo Mirror: Eyra 100x80 cm / 5500°k

# Yves + sensor touch

| CM     | W LED | LUMENS | W ANTIVAH/Opción<br>W DEFOGGER/Optional |
|--------|-------|--------|---|
| 60x80  | 19.84 | 1860   | 16                                      |
| 80x80  | 23.04 | 2160   | 30                                      |
| 100x80 | 26.24 | 2460   | 46                                      |
| 120x80 | 29.44 | 27.60  | 70                                      |
| 140x80 | 32.64 | 3060   | 70                                      |



Producto disponible a medida  
Measures available on request

Opciones / Options :

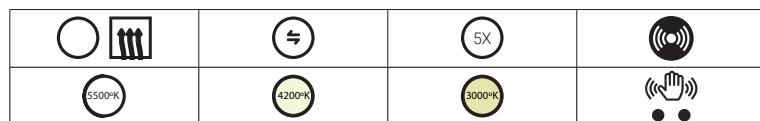

Ficha técnica / Technical sheet :

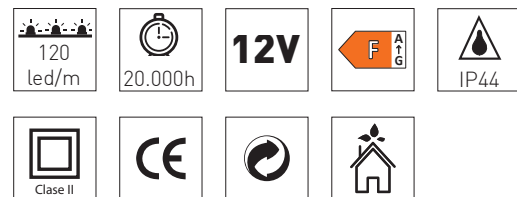

Acabado acero / Steel finish



Acabado negro / Black finish

Montaje 1 / Construction 1



\* Espejo Foto / Photo Mirror: Yves 3led 80x80 cm / 5500°k ○

# Lisbeth

| CM     | W LED | LUMENS | W ANTIVAH/Opción<br>W DEFOGGER/Optional |
|--------|-------|--------|---|
| 60x80  | 19.84 | 1860   | 16                                      |
| 80x80  | 23.04 | 2160   | 30                                      |
| 100x80 | 26.24 | 2460   | 46                                      |
| 120x80 | 29.44 | 2760   | 70                                      |
| 140x80 | 32.64 | 30.60  | 70                                      |



Producto disponible a medida  
Measures available on request

Opciones / Options :

|  |  |  |  |
|--|--|--|--|
|  |  |  |  |
|  |  |  |  |
|  |  |  |  |
|  |  |  |  |

Ficha técnica / Technical sheet :

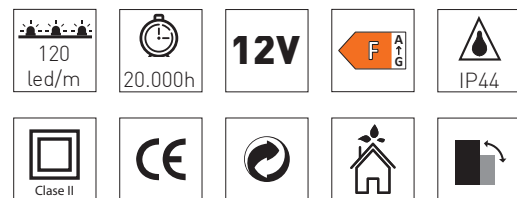

Acabado acero / Steel finish



Acabado negro / Black finish

Montaje 1 / Construction 1



\* Espejo Foto: Lisbeth 120x80 cm c/sensor movimiento / 5500°k  
\* Photo Mirror: Lisbeth 120x80 cm with movement sensor / 5500°k



# Alice

| CM     | W LED | LUMENS | W ANTIVAHÓ/Opción<br>W DEFOGGER/Optional |
|--------|-------|--------|--|
| 60x80  | 19.84 | 1860   | 16                                       |
| 80x80  | 23.04 | 2160   | 30                                       |
| 100x80 | 26.24 | 2460   | 46                                       |
| 120x80 | 29.44 | 2760   | 70                                       |
| 140x80 | 32.64 | 3060   | 70                                       |



Producto disponible a medida  
Measures available on request

Opciones / Options :

|  |  |  |  |
|--|--|--|--|
|  |  |  |  |
|  |  |  |  |
|  |  |  |  |
|  |  |  |  |

Montaje 1 / 1

Acabado acero / Steel finish

Acabado negro / Black finish



Ficha técnica / Technical sheet :

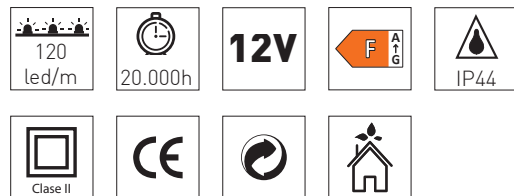

Screen mirror OPCIONAL / OPTIONAL screen mirror system

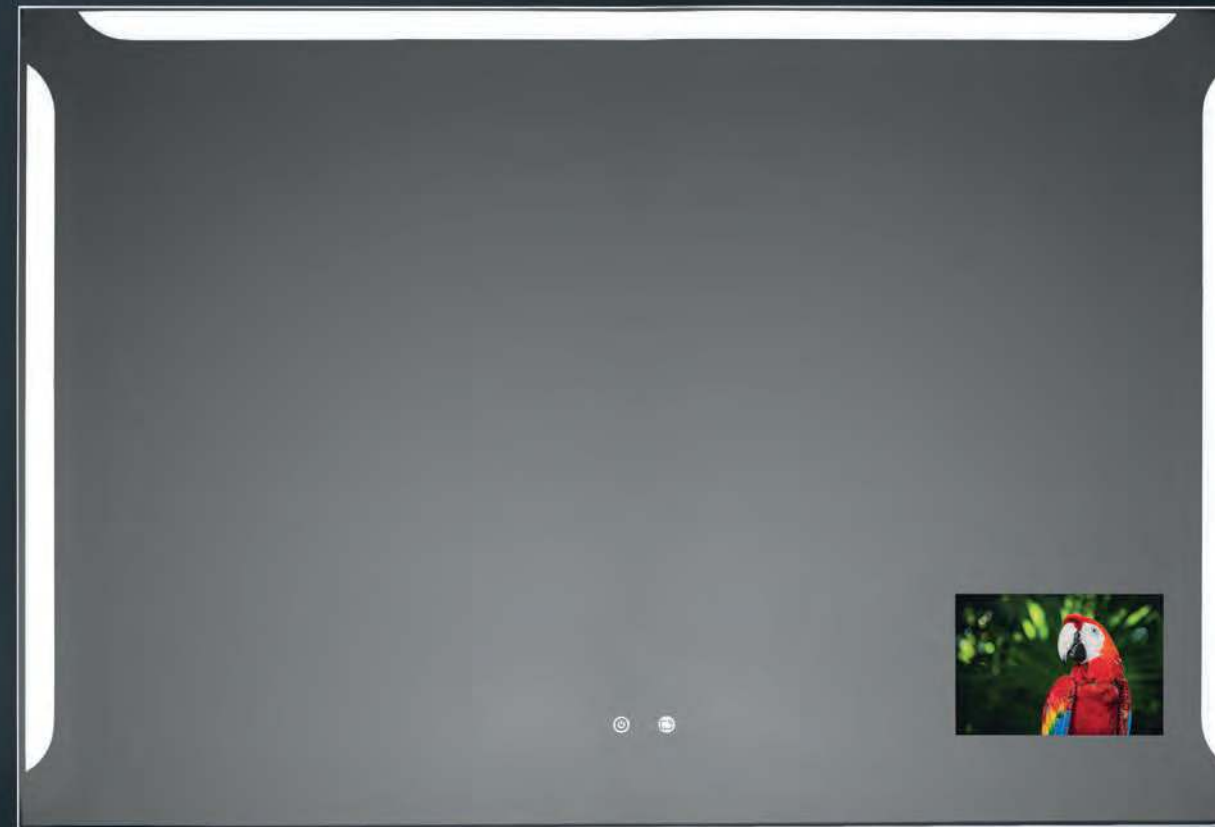

\* Espejo Foto / Photo Mirror: Alice Screen Mirror 120x80 cm / 5500°k



# Osna

| CM     | W LED | LUMENS | W ANTIVAHU/Opción<br>W DEFOGGER/Optional |
|--------|-------|--------|--|
| 60X80  | 9.60  | 900    | 13                                       |
| 80x80  | 12.80 | 1200   | 30                                       |
| 100x80 | 16.00 | 1500   | 46                                       |
| 120x80 | 19.20 | 1800   | 70                                       |
| 140X80 | 22.40 | 2100   | 70                                       |

Producto disponible a medida  
Measures available on request

Opciones / Options :

|  |  |  |  |
|--|--|--|--|
|  |  |  |  |
|  |  |  |  |
|  |  |  |  |
|  |  |  |  |

Ficha técnica / Technical sheet :

|  |  |            |  |  |
|--|--|------------|--|--|
|  |  | <b>12V</b> |  |  |
|  |  |            |  |  |



Acabado acero / Steel finish



Opción / Optional



Acabado negro / Black finish



Opción / Optional

Montaje 1 / Construction 1

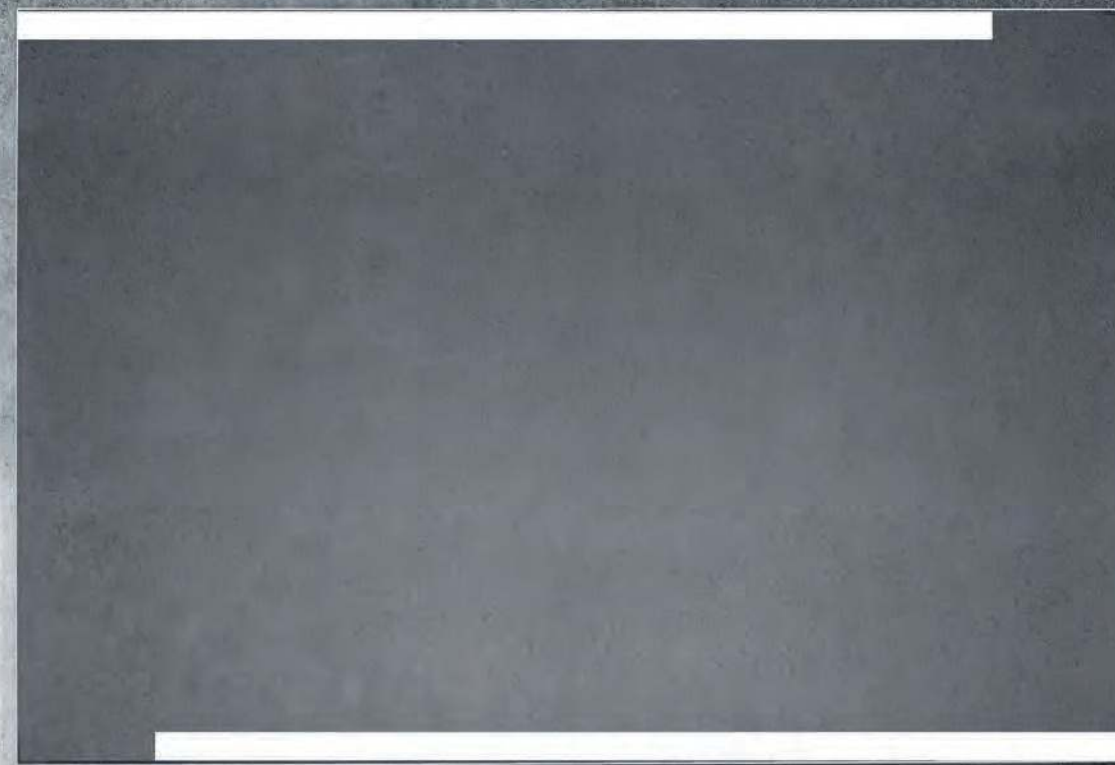

\* Espejo Foto / Photo Mirror: Osna 120x80 cm / 5500°k

# Emin

| CM     | W LED | LUMENS | W ANTIVAH/Opción<br>W DEFOGGER/Optional |
|--------|-------|--------|---|
| 60x80  | 19.84 | 1860   | 16                                      |
| 80x80  | 23.04 | 2160   | 30                                      |
| 100x80 | 26.24 | 2460   | 46                                      |
| 120x80 | 29.44 | 2760   | 70                                      |
| 140x80 | 32.64 | 3060   | 70                                      |



Producto disponible a medida  
Measures available on request

Opciones / Options :

|  |  |  |  |
|--|--|--|--|
|  |  |  |  |
|  |  |  |  |
|  |  |  |  |
|  |  |  |  |

Ficha técnica / Technical sheet :

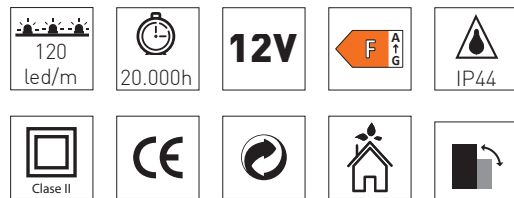

Acabado acero / Steel finish



Acabado negro / Black finish

Montaje 1 / Construction 1



\* Espejo Foto / Photo Mirror: Emin 120x80 cm / 5500°k

# Gredos

| CM     | W LED | LUMENS | W ANTIVAH/Opción<br>W DEFOGGER/Optional |
|--------|-------|--------|---|
| 60x80  | 9.60  | 900    | 16                                      |
| 80x80  | 12.80 | 1200   | 30                                      |
| 100x80 | 16.00 | 1500   | 46                                      |
| 120x80 | 19.20 | 1800   | 70                                      |
| 140x80 | 22.40 | 2100   | 70                                      |



Producto disponible a medida  
Measures available on request

Opciones / Options :

|  |  |  |  |
|--|--|--|--|
|  |  |  |  |
|  |  |  |  |
|  |  |  |  |
|  |  |  |  |

Ficha técnica / Technical sheet :

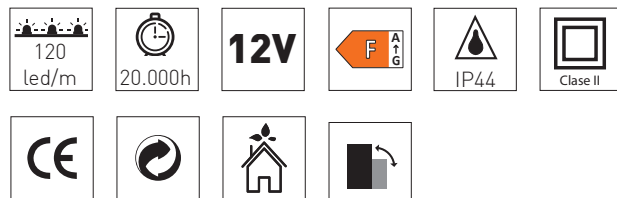

Montaje 18 / Construction 18

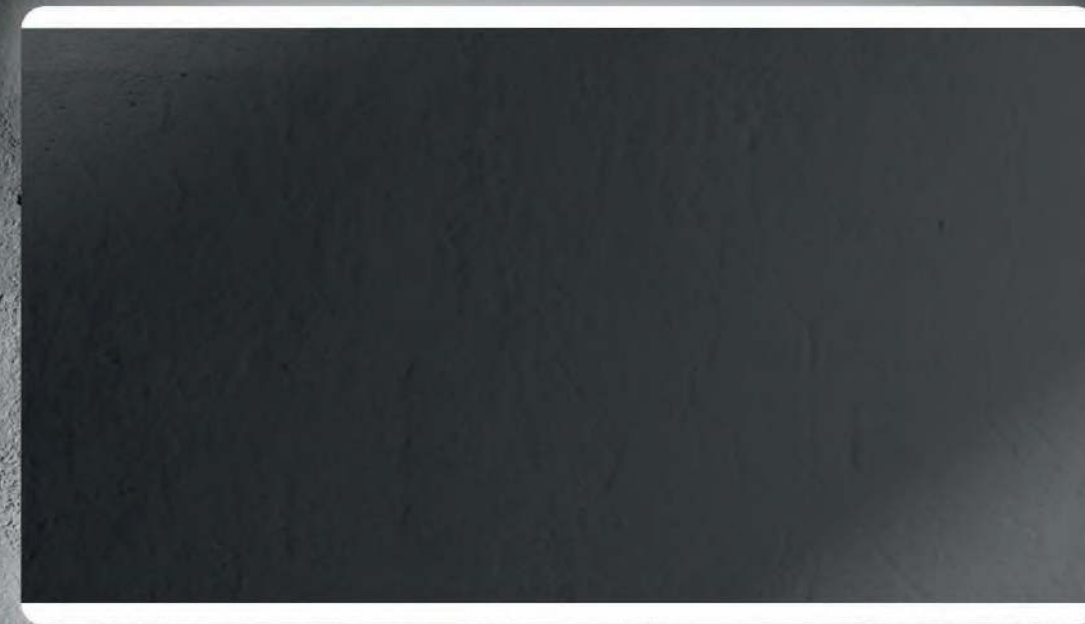

\* Espejo Foto / Photo Mirror: Gredos 120x80 cm / 5500°k

# Arán

| CM     | W LED | LUMENS | W ANTIVAHÓ/Opción<br>W DEFOGGER/Optional |
|--------|-------|--------|--|
| 60x80  | 15.50 | 1615   | 16                                       |
| 80x80  | 15.50 | 1615   | 30                                       |
| 100x80 | 15.50 | 1615   | 46                                       |
| 120x80 | 15.50 | 1615   | 70                                       |
| 140x80 | 15.50 | 1615   | 70                                       |



Opciones / Options :

|  |  |  |  |
|--|--|--|--|
|  |  |  |  |
|  |  |  |  |
|  |  |  |  |

Ficha técnica / Technical sheet :

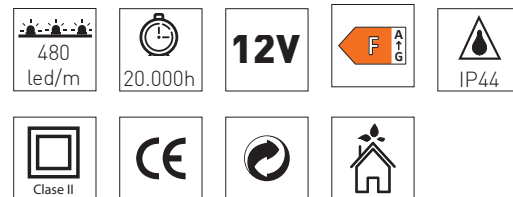

Montaje 7 / Construction 7



\* Espejo Foto / Photo Mirror: Aran 60x80 cm / 5500°k

# Paris

| CM     | W LED | LUMENS | W ANTIVAH/Opción<br>W DEFOGGER/Optional |
|--------|-------|--------|---|
| 60x80  | 9.60  | 900    | 16                                      |
| 80x80  | 12.80 | 1200   | 30                                      |
| 100x80 | 16.00 | 1500   | 46                                      |
| 120x80 | 19.20 | 1800   | 70                                      |
| 140x80 | 22.40 | 2100   | 70                                      |



Producto disponible a medida  
Measures available on request

Opciones / Options :

|  |  |  |  |
|--|--|--|--|
|  |  |  |  |
|  |  |  |  |
|  |  |  |  |
|  |  |  |  |

Ficha técnica / Technical sheet :

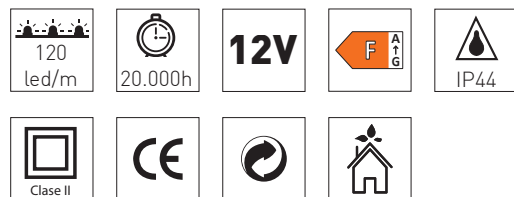

Acabado acero / Steel finish



Acabado negro / Black finish

Montaje 1 / Construction 1



\* Espejo Foto / Photo Mirror: Paris 100x80 cm / 5500°k

# Astro

| CM     | W LED | LUMENS | W ANTIVAHÓ/Opción<br>W DEFOGGER/Optional |
|--------|-------|--------|--|
| 60x80  | 23.20 | 2417   | 16                                       |
| 80x80  | 27.20 | 2834   | 30                                       |
| 100x80 | 31.20 | 3251   | 46                                       |
| 120x80 | 35.20 | 3667   | 70                                       |
| 140x80 | 39.20 | 4084   | 70                                       |



Producto disponible a medida  
Measures available on request

Opciones / Options :

|  |  |  |  |
|--|--|--|--|
|  |  |  |  |
|  |  |  |  |
|  |  |  |  |

Ficha técnica / Technical sheet :



Montaje 14 / Construction 14

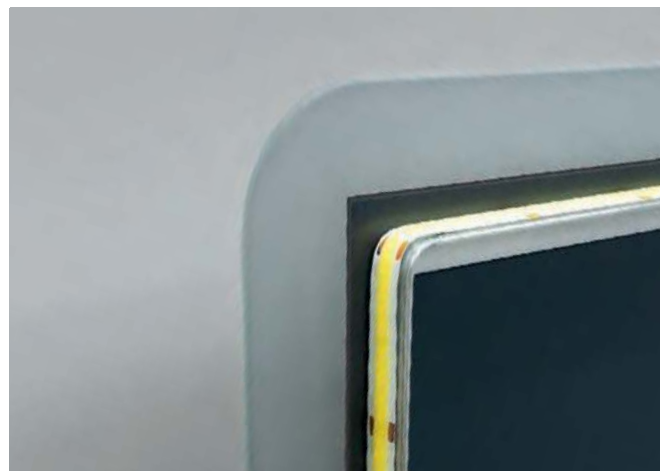

\* Espejo Foto / Photo Mirror: Astro 100x80 cm / 5500°k  

# Jaspe Led

| CM    | W LED | LUMENS | W ANTIVAHÓ/Opción<br>W DEFOGGER/Optional |
|-------|-------|--------|--|
| 40x80 | 185   | 1927   | 18.5                                     |



Opciones / Options :

|  |  |  |  |
|--|--|--|--|
|  |  |  |  |
|  |  |  |  |
|  |  |  |  |

Ficha técnica / Technical sheet :

|  |  |            |  |          |
|--|--|------------|--|----------|
|  |  | <b>12V</b> |  |          |
|  |  |            |  | Clase II |

Montaje 13 / Construction 13



\* Espejo Foto / Photo Mirror: Jaspe 40x80 cm / 5500°k

# Mireia Led

| CM    | W LED | LUMENS | W ANTIVAHÓ/Opción<br>W DEFOGGER/Optional |
|-------|-------|--------|--|
| 45X90 | 24    | 2500   | 16                                       |

Opciones / Options :

|  |  |  |  |
|--|--|--|--|
|  |  |  |  |
|  |  |  |  |
|  |  |  |  |

Ficha técnica / Technical sheet :

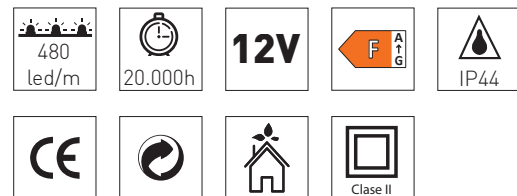

Montaje 13 / Construction 13



\* Espejo Foto / Photo Mirror: Mireia 45x90 cm / 5500°k



# Khan

| CM     | W LED | LUMENS | W ANTIVAHU/Opción<br>W DEFOGGER/Optional |
|--------|-------|--------|--|
| 60x80  | 26.40 | 2750   | 16                                       |
| 80x80  | 30.40 | 3167   | 46                                       |
| 100x80 | 34.40 | 3584   | 60                                       |
| 120x80 | 38.40 | 4001   | 70                                       |
| 140x80 | 42.40 | 4418   | 70                                       |



Producto disponible a medida  
Measures available on request

Opciones / Options :

|  |  |  |  |
|--|--|--|--|
|  |  |  |  |
|  |  |  |  |
|  |  |  |  |

Ficha técnica / Technical sheet :

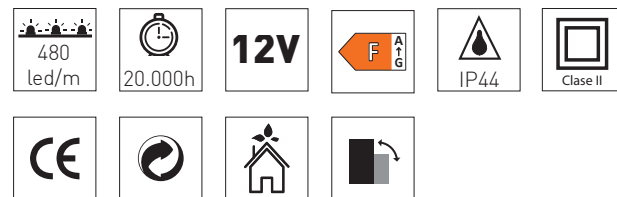

Montaje 3 / Construction 3



\* Espejo Foto / Photo Mirror: Khan 80x80 cm / 5500°k

# Shira

| CM     | W LED | LUMENS | W ANTIVAHÓ/Opción<br>W DEFOGGER/Optional |
|--------|-------|--------|--|
| 60x80  | 21.12 | 1980   | 16                                       |
| 80x80  | 24.32 | 2280   | 46                                       |
| 100x80 | 27.62 | 2580   | 60                                       |
| 120x80 | 30.72 | 2880   | 70                                       |
| 140x80 | 33.92 | 3180   | 70                                       |



Producto disponible a medida  
Measures available on request

Opciones / Options :

|  |  |  |  |
|--|--|--|--|
|  |  |  |  |
|  |  |  |  |
|  |  |  |  |

Ficha técnica / Technical sheet :

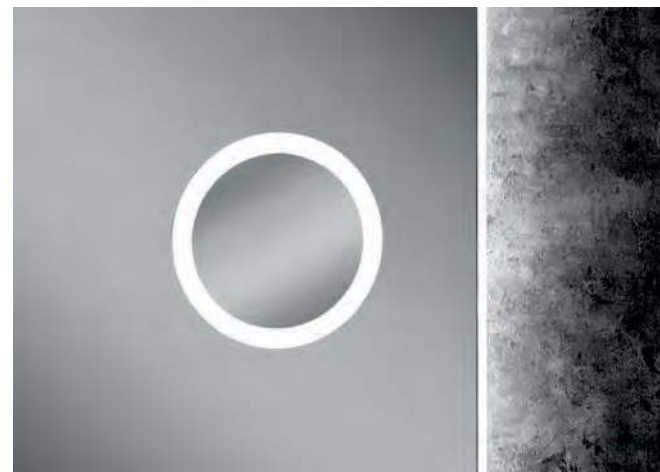
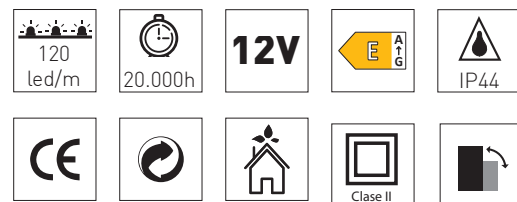

Espejo aumento 5x OPCIONAL / 5x Magnifying mirror OPTIONAL

Montaje 2 / Construction 2



\* Espejo Foto / Photo Mirror: Shira 100x80 cm / 3000/4200/5500°k



# Amira

| CM     | W LED | LUMENS | W ANTIVAH/Opción<br>W DEFOGGER/Optional |
|--------|-------|--------|---|
| 60x80  | 24.80 | 2584   | 16                                      |
| 80x80  | 28.80 | 3000   | 30                                      |
| 100x80 | 32.80 | 3418   | 46                                      |
| 120x80 | 36.80 | 3834   | 70                                      |
| 140x80 | 40.80 | 4251   | 70                                      |

Opciones / Options :

|  |  |  |  |
|--|--|--|--|
|  |  |  |  |
|  |  |  |  |
|  |  |  |  |

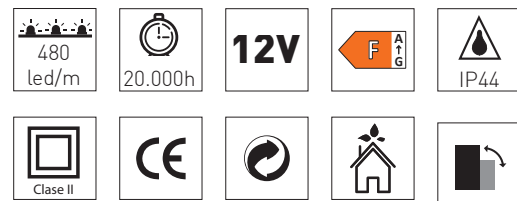

Montaje 3 / Construction 3



\* Espejo Foto / Photo Mirror: Amira 60x80 cm / 5500°k

# Bera Redondo

| CM  | W LED | LUMENS | W ANTIVAHU/Opción<br>W DEFOGGER/Optional |
|-----|-------|--------|--|
| Ø60 | 11.84 | 1110   | 10                                       |
| Ø80 | 16.80 | 1575   | 16                                       |



Opciones / Options :

|  |  |  |  |
|--|--|--|--|
|  |  |  |  |
|  |  |  |  |
|  |  |  |  |

Ficha técnica / Technical sheet :

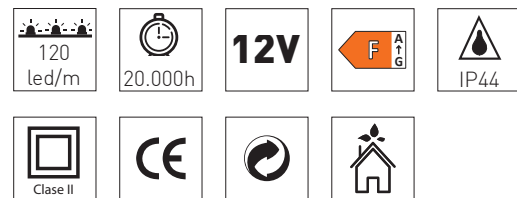

Montaje 4 / Construction 4



\* Espejo Foto / Photo Mirror: Bera Redondo Ø 60 cm / 5500°k

# Bera Rectangular

| CM     | W LED | LUMENS | W ANTIVAHÓ/Opción<br>W DEFOGGER/Optional |
|--------|-------|--------|--|
| 60X80  | 19.84 | 1860   | 18                                       |
| 80X80  | 23.04 | 2160   | 30                                       |
| 100X80 | 26.24 | 2460   | 46                                       |
| 120X80 | 29.44 | 2760   | 70                                       |
| 140X80 | 32.64 | 3060   | 70                                       |



Producto disponible a medida  
Measures available on request

Opciones / Options :

|  |  |  |  |
|--|--|--|--|
|  |  |  |  |
|  |  |  |  |
|  |  |  |  |

Ficha técnica / Technical sheet :

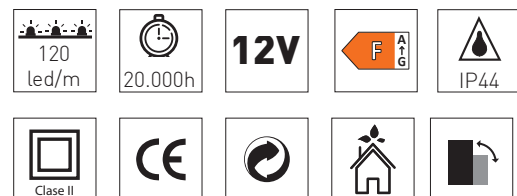

Acabado acero / Steel finish



Acabado negro / Black finish

Montaje 1 / Construction 1



\* Espejo Foto / Photo Mirror: Bera Rectangular 80x80 cm / 5500°k

# Dalía Redondo

| CM  | W LED | LUMENS | W ANTIVAHÓ/Opción<br>W DEFOGGER/Optional |
|-----|-------|--------|--|
| Ø60 | 11.84 | 1110   | 10                                       |
| Ø80 | 16.80 | 1575   | 16                                       |



Opciones / Options :

|  |  |  |  |
|--|--|--|--|
|  |  |  |  |
|  |  |  |  |
|  |  |  |  |

Ficha técnica / Technical sheet :

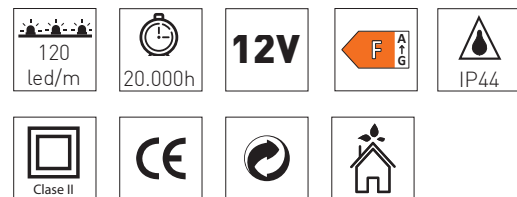

Montaje 4 / Construction 4



\* Espejo Foto / Photo Mirror: Dalía Redondo Ø 60 cm / 5500°k

# Dalía Rectangular

| CM     | W LED | LUMENS | W ANTIVAHÓ/Opción<br>W DEFOGGER/Optional |
|--------|-------|--------|--|
| 60X80  | 19.84 | 1860   | 16                                       |
| 80X80  | 23.04 | 2160   | 30                                       |
| 100X80 | 26.24 | 2460   | 40                                       |
| 120X80 | 39.44 | 2760   | 70                                       |
| 140X80 | 32.64 | 3060   | 70                                       |



Opciones / Options :

|  |  |  |  |
|--|--|--|--|
|  |  |  |  |
|  |  |  |  |
|  |  |  |  |

Ficha técnica / Technical sheet :

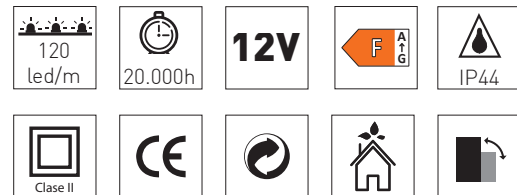

Acabado acero / Steel finish



Acabado negro / Black finish

Montaje 1 / Construction 1



\* Espejo Foto / Photo Mirror: Dalía Rectangular 80x80 cm / 5500°k

# Siro Redondo

| CM   | W LED | LUMENS | W ANTIVAH/Opción<br>W DEFOGGER/Optional |
|------|-------|--------|---|
| Ø60  | 18.20 | 1896   | 10                                      |
| Ø70  | 21.40 | 2229   | 10                                      |
| Ø80  | 24.50 | 2552   | 30                                      |
| Ø90  | 27.60 | 2875   | 46                                      |
| Ø100 | 30.80 | 3209   | 60                                      |
| Ø120 | 37.10 | 3865   | 70                                      |



Opciones / Options :

|  |  |  |  |
|--|--|--|--|
|  |  |  |  |
|  |  |  |  |
|  |  |  |  |

Ficha técnica / Technical sheet :

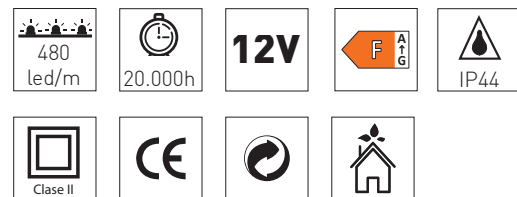

Montaje 5 / Construction 5



\* Espejo Foto / Photo Mirror: Siro Redondo 80 cm / 5500°k



# Siro Rectangular

| CM     | W LED | LUMENS | W ANTIVAHÓ/Opción<br>W DEFOGGER/Optional |
|--------|-------|--------|--|
| 60x80  | 26.40 | 2750   | 16                                       |
| 80x80  | 30.40 | 3167   | 30                                       |
| 100x80 | 34.40 | 3584   | 60                                       |
| 120x80 | 38.40 | 4001   | 70                                       |
| 140x80 | 42.40 | 4418   | 70                                       |



Opciones / Options :

|  |  |  |  |
|--|--|--|--|
|  |  |  |  |
|  |  |  |  |
|  |  |  |  |

Ficha técnica / Technical sheet :

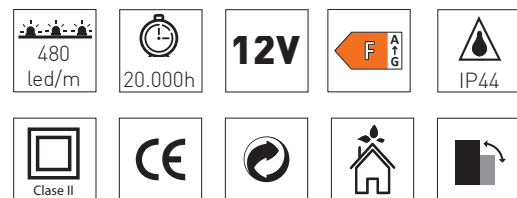

Montaje 3 / Construction 3



\* Espejo Foto / Photo Mirror: Siro Rectangular 80x80 cm / 5500°k

# Siro Cápsula

| CM    | W LED | LUMENS | W ANTIVAHÓ/Opción<br>W DEFOGGER/Optional |
|-------|-------|--------|--|
| 45X90 | 22.50 | 2344   | 10                                       |



Opciones / Options :

|  |  |  |  |
|--|--|--|--|
|  |  |  |  |
|  |  |  |  |
|  |  |  |  |

Ficha técnica / Technical sheet :

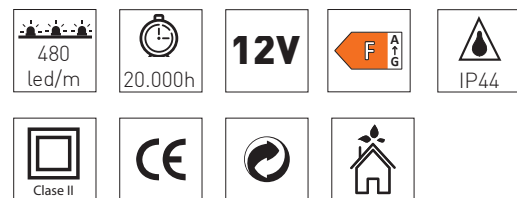

Montaje 5 / Construction 5



\* Espejo Foto / Photo Mirror: Cápsula 45x90 cm / 5500°k

# Salma Redondo Bisel Luz

| CM    | W LED | LUMENS | W ANTIVAHÓ/Opción<br>W DEFOGGER/Optional |
|-------|-------|--------|--|
| Ø60   | 18.20 | 1896   | 16                                       |
| 16Ø70 | 21.40 | 2229   | 16                                       |
| Ø80   | 24.50 | 2552   | 30                                       |
| Ø90   | 27.60 | 2875   | 46                                       |
| Ø100  | 30.80 | 3209   | 46                                       |
| Ø120  | 37.10 | 3865   | 70                                       |

Opciones / Options :

|  |  |  |  |
|--|--|--|--|
|  |  |  |  |
|  |  |  |  |
|  |  |  |  |

Ficha técnica / Technical sheet :

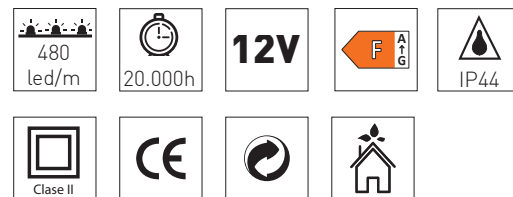

Montaje 5 / Construction 5



\* Espejo Foto / Photo Mirror: Salma Redondo Ø60 / 5500°k

# Salma Rectangular Bisel Luz

| CM     | W LED | LUMENS | W ANTIVAH/Opción<br>W DEFOGGER/Optional |
|--------|-------|--------|---|
| 60x80  | 26.40 | 2750   | 16                                      |
| 80x80  | 30.40 | 3167   | 30                                      |
| 100x80 | 34.40 | 3584   | 46                                      |
| 120x80 | 38.40 | 4001   | 70                                      |
| 140x80 | 42.40 | 4418   | 70                                      |



Opciones / Options :

|  |  |  |  |
|--|--|--|--|
|  |  |  |  |
|  |  |  |  |
|  |  |  |  |

Ficha técnica / Technical sheet :

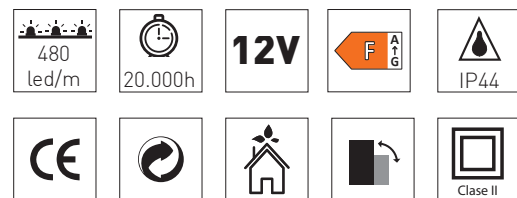

Montaje 3 / Construction 3

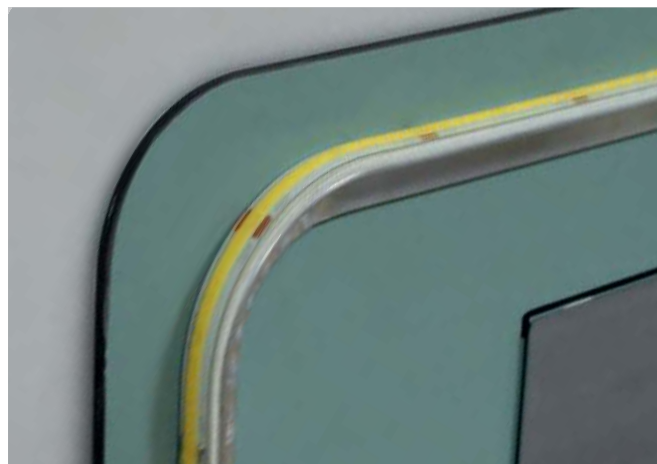

\* Espejo Foto / Photo Mirror: Salma Rectangular 80x80 / 5500°k

# Salma Cápsula Bisel Luz

| CM    | W LED | LUMENS | W ANTIVAHÓ/Opción<br>W DEFOGGER/Optional |
|-------|-------|--------|--|
| 45X90 | 22.50 | 2344   | 16                                       |



Opciones / Options :

|  |  |  |  |
|--|--|--|--|
|  |  |  |  |
|  |  |  |  |
|  |  |  |  |

Ficha técnica / Technical sheet :

|  |  |  |  |  |
|--|--|--|--|--|
|  |  |  |  |  |
|  |  |  |  |  |

Montaje 3 / Construction 3



\* Espejo Foto / Photo Mirror: Salma Cápsula 45x90 cm / 5500°k

# Celia Redondo

| CM  | W LED | LUMENS | W ANTIVAHÓ/Opción<br>W DEFOGGER/Optional |
|-----|-------|--------|--|
| Ø60 | 14.32 | 1343   | 10                                       |
| Ø80 | 19.36 | 1815   | 30                                       |



Opciones / Options :

|  |  |  |  |
|--|--|--|--|
|  |  |  |  |
|  |  |  |  |
|  |  |  |  |

Ficha técnica / Technical sheet :

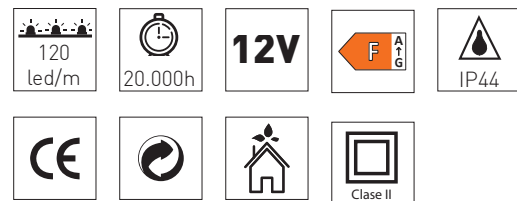

Montaje 11 / Construction 11



\* Espejo Foto / Photo Mirror: Celia Redondo Ø80 cm / 5500°k

# Celia Rectangular

| CM     | W LED | LUMENS | W ANTIVAHU/Opción<br>W DEFOGGER/Optional |
|--------|-------|--------|--|
| 60x80  | 21.44 | 2010   | 16                                       |
| 80x80  | 24.64 | 2310   | 30                                       |
| 100x80 | 27.84 | 2610   | 46                                       |
| 120x80 | 31.04 | 2910   | 70                                       |
| 140x80 | 34.24 | 3210   | 70                                       |



Opciones / Options :

|  |  |  |  |
|--|--|--|--|
|  |  |  |  |
|  |  |  |  |
|  |  |  |  |

Ficha técnica / Technical sheet :

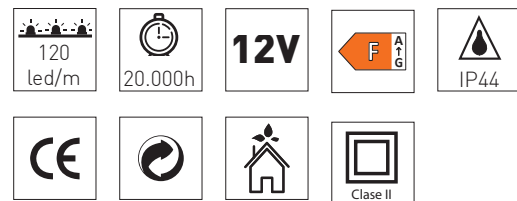

Montaje 11 / Construction 11



\* Espejo Foto / Photo Mirror: Celia Rectangular 120x80 cm / 5500°k

# Celia Cápsula

| CM    | W LED | LUMENS | W ANTIVAH/Opción<br>W DEFOGGER/Optional |
|-------|-------|--------|---|
| 45x90 | 17.76 | 1665   | 16                                      |



Opciones / Options :

|  |  |  |  |
|--|--|--|--|
|  |  |  |  |
|  |  |  |  |
|  |  |  |  |

Ficha técnica / Technical sheet :

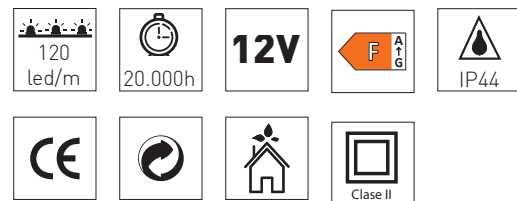

Montaje 11 / Construction 11



\* Espejo Foto / Photo Mirror: Celia Cápsula 45x90 cm / 5500°k



# Emma Redondo

| CM   | W LED | LUMENS | W ANTIVAH/Opción<br>W DEFOGGER/Optional |
|------|-------|--------|---|
| Ø60  | 17.60 | 1833   | 16                                      |
| Ø70  | 20.70 | 2156   | 16                                      |
| Ø80  | 23.90 | 2490   | 30                                      |
| Ø90  | 27.00 | 2813   | 46                                      |
| Ø100 | 30.20 | 3146   | 46                                      |



Acabado negro / Black finish



Acabado oro / Gold finish

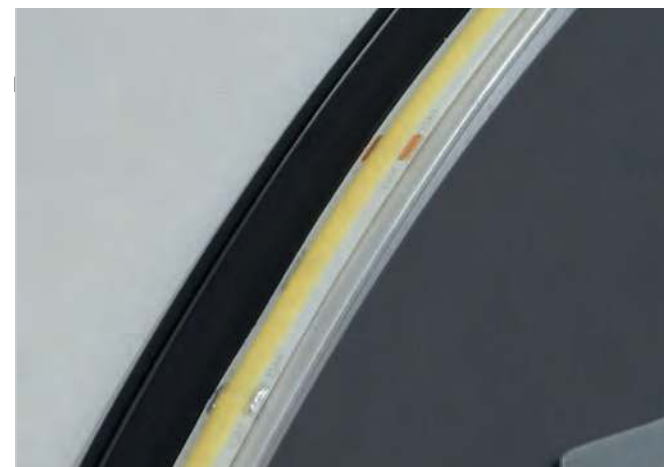

Montaje 5/ Construction 5

Opciones / Options :

|  |  |  |  |
|--|--|--|--|
|  |  |  |  |
|  |  |  |  |
|  |  |  |  |

Ficha técnica / Technical sheet :

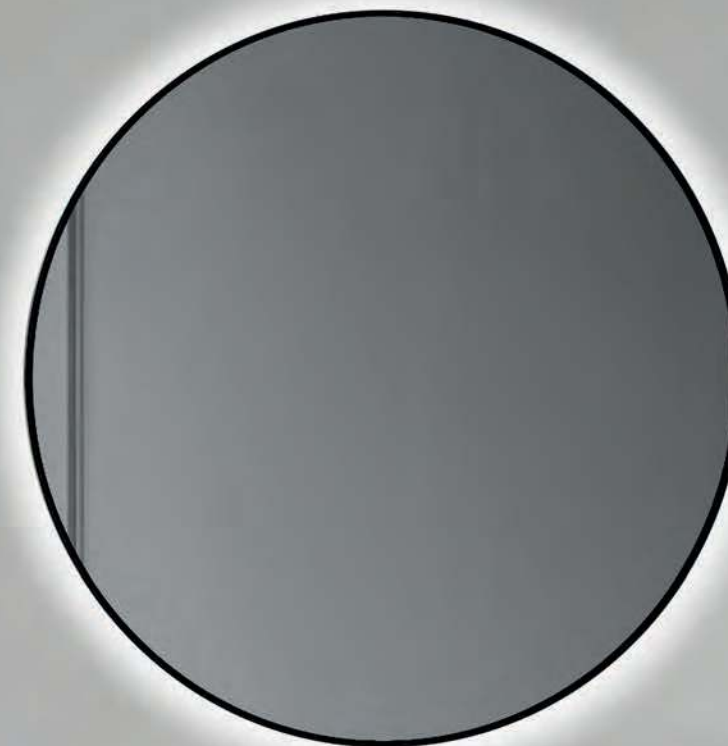
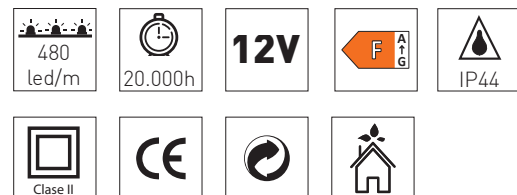

\* Espejo Foto / Photo Mirror: Emma Ø80 cm / 5500°k

# Emma Rectangular

| CM     | W LED | LUMENS | W ANTIVAHÓ/Opción<br>W DEFOGGER/Optional |
|--------|-------|--------|--|
| 60x80  | 26.40 | 2750   | 16                                       |
| 80x80  | 30.40 | 3168   | 45                                       |
| 100x80 | 34.40 | 3584   | 60                                       |
| 120x80 | 38.40 | 4001   | 70                                       |
| 140x80 | 42.40 | 4418   | 70                                       |



Producto disponible a medida  
Measures available on request

Opciones / Options :

|  |  |  |  |
|--|--|--|--|
|  |  |  |  |
|  |  |  |  |
|  |  |  |  |

Ficha técnica / Technical sheet :

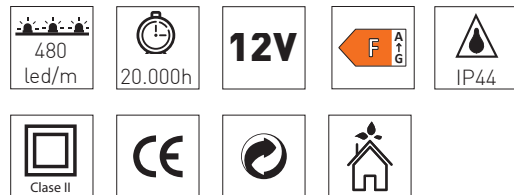

Acabado negro / Black finish



Acabado oro / Gold finish

Montaje 3 / Construction 3

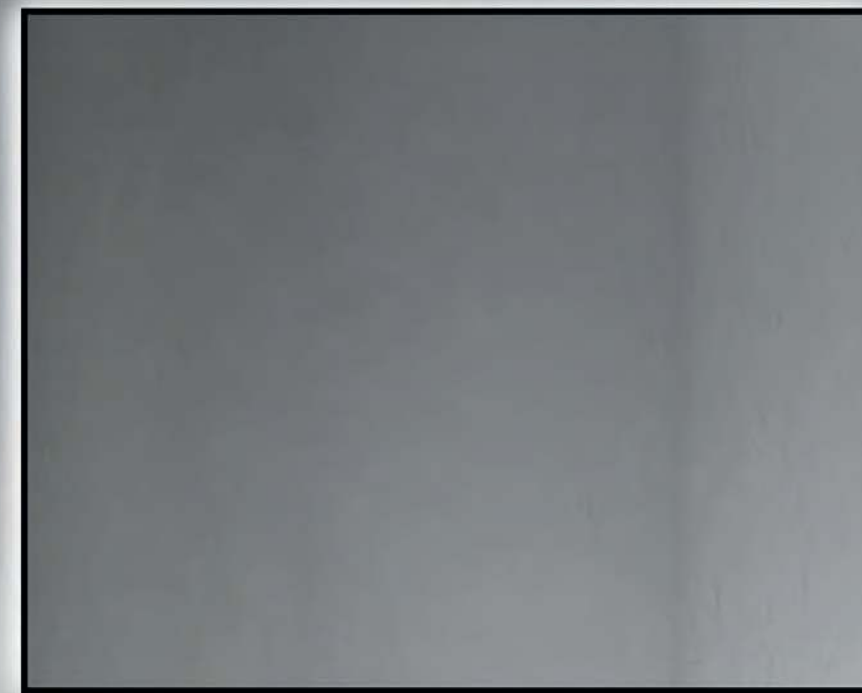

\* Espejo Foto / Photo Mirror: Emma 100x80 cm / 5500°k

# Emma Cápsula

| CM    | W LED | LUMENS | W ANTIVAH/Opción<br>W DEFOGGER/Optional |
|-------|-------|--------|---|
| 45X90 | 22.50 | 2344   | 16                                      |



Acabado negro / Black finish



Acabado oro / Gold finish

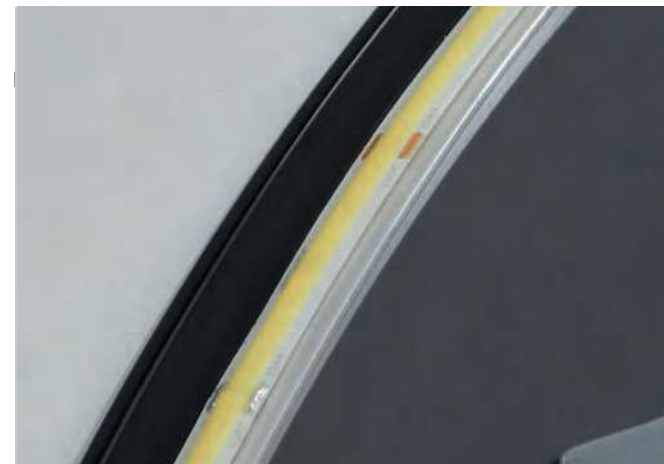

Montaje 5 / Construction 5

Opciones / Options :

|  |  |  |  |
|--|--|--|--|
|  |  |  |  |
|  |  |  |  |
|  |  |  |  |

Ficha técnica / Technical sheet :

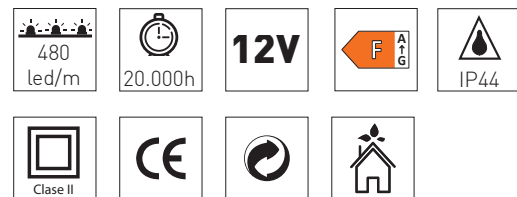

\* Espejo Foto / Photo Mirror: Emma Cápsula 45x90 cm / 5500°k

# Kea Eco Redondo

| CM   | W LED | LUMENS | W ANTIVAHÓ/Opción<br>W DEFOGGER/Optional |
|------|-------|--------|--|
| Ø60  | 14.80 | 1542   | 16                                       |
| Ø70  | 17.90 | 1865   | 16                                       |
| Ø80  | 21.00 | 2188   | 30                                       |
| Ø90  | 24.20 | 2421   | 46                                       |
| Ø100 | 27.30 | 2844   | 46                                       |



## Opciones / Options :

|  |  |  |  |
|--|--|--|--|
|  |  |  |  |
|  |  |  |  |
|  |  |  |  |

## Ficha técnica / Technical sheet :

|  |  |  |  |  |
|--|--|--|--|--|
|  |  |  |  |  |
|  |  |  |  |  |

## Montaje 14 / Construction 14



\* Espejo Foto / Photo Mirror: Kea Eco Redondo Ø80 cm / 5500°k

# Kea Eco Rectangular

| CM     | W LED | LUMENS | W ANTIVAH/Opción<br>W DEFOGGER/Optional |
|--------|-------|--------|---|
| 60x80  | 22.20 | 2313   | 16                                      |
| 80x80  | 26.20 | 2730   | 30                                      |
| 100x80 | 30.20 | 3146   | 46                                      |
| 120x80 | 34.20 | 3563   | 70                                      |
| 140x80 | 38.20 | 3980   | 70                                      |



Producto disponible a medida  
Measures available on request

Opciones / Options :

|  |  |  |  |
|--|--|--|--|
|  |  |  |  |
|  |  |  |  |
|  |  |  |  |

Ficha técnica / Technical sheet :

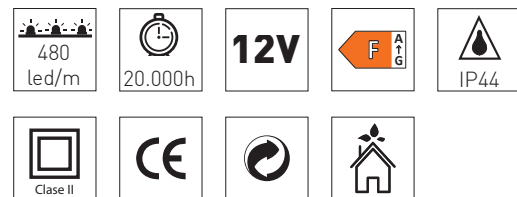

Montaje 14 / Construction 14



\* Espejo Foto / Photo Mirror: Kea Eco Rectangular 60x80 cm / 5500°k

# Kea Eco Cápsula

| CM    | W LED | LUMENS | W ANTIVAHÓ/Opción<br>W DEFOGGER/Optional |
|-------|-------|--------|--|
| 45x90 | 22.50 | 2344   | 16                                       |



Opciones / Options :

|  |  |  |  |
|--|--|--|--|
|  |  |  |  |
|  |  |  |  |
|  |  |  |  |

Ficha técnica / Technical sheet :

|  |  |            |  |  |
|--|--|------------|--|--|
|  |  | <b>12V</b> |  |  |
|  |  |            |  |  |

Montaje 14 / Construction 14



\* Espejo Foto / Photo Mirror: Kea Eco Cápsula 45x90 cm / 5500°k

# Zoe Redondo

| Ø CM | W ANTIVAHU/Opción<br>W DEFOGGER/Optional |
|------|--|
| 60   | 16                                       |
| 80   | 30                                       |

Opciones / Options :



Ficha técnica / Technical sheet :



Marco metálico acabado negro / Metallic frame black finish

Montaje 17 / Construction 17

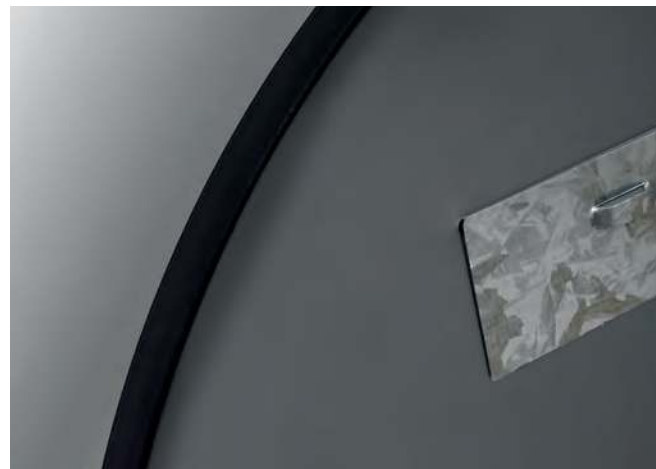

\* Espejo Foto / Photo Mirror: Zoe Redondo Ø60 cm

# Zoe Rectangular

| CM     | W ANTIVAHÓ/Opción<br>W DEFOGGER/Optional |
|--------|--|
| 60x80  | 16                                       |
| 80x80  | 30                                       |
| 100x80 | 46                                       |
| 120x80 | 70                                       |



Producto disponible a medida  
Measures available on request

Opciones / Options :



Ficha técnica / Technical sheet :



Marco metálico acabado negro / Metallic frame black finish

Montaje 17 / Construction 17

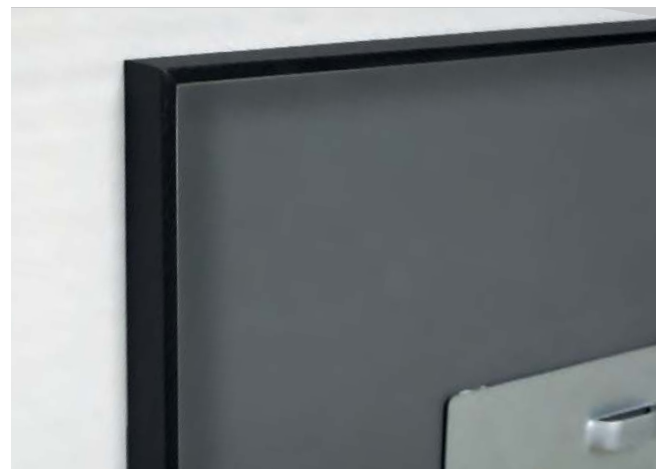

\* Espejo Foto / Photo Mirror: Zoe Rectangular 80x80 cm



# Zoe Redondo Led

| CM  | W LED | LUMENS | W ANTIVAH0/Opción<br>W DEFOGGER/Optional |
|-----|-------|--------|--|
| Ø60 | 18.20 | 1896   | 16                                       |
| Ø80 | 24.50 | 2552   | 30                                       |



Marco metálico acabado negro / Metallic frame black finish

Opciones / Options :

|  |  |  |  |
|--|--|--|--|
|  |  |  |  |
|  |  |  |  |
|  |  |  |  |

Montaje 16 / Construction 16



Ficha técnica / Technical sheet :

|  |  |  |  |  |
|--|--|--|--|--|
|  |  |  |  |  |
|  |  |  |  |  |



\* Espejo Foto / Photo Mirror: Zoe Rectangular LED Ø60 cm / 5500°k

# Zoe Rectangular Led

| CM     | W LED | LUMENS | W ANTIVAH0/Opción<br>W DEFOGGER/Optional |
|--------|-------|--------|--|
| 60x80  | 26.40 | 2750   | 16                                       |
| 80x80  | 30.40 | 3167   | 30                                       |
| 100x80 | 38.40 | 4001   | 46                                       |
| 120x80 | 42.40 | 4418   | 70                                       |



Marco metálico acabado negro / Metallic frame black finish

Opciones / Options :

|  |  |  |  |
|--|--|--|--|
|  |  |  |  |
|  |  |  |  |
|  |  |  |  |

Ficha técnica / Technical sheet :

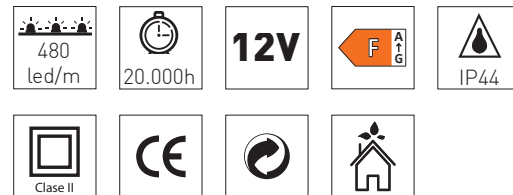

Montaje 16 / Construction 16

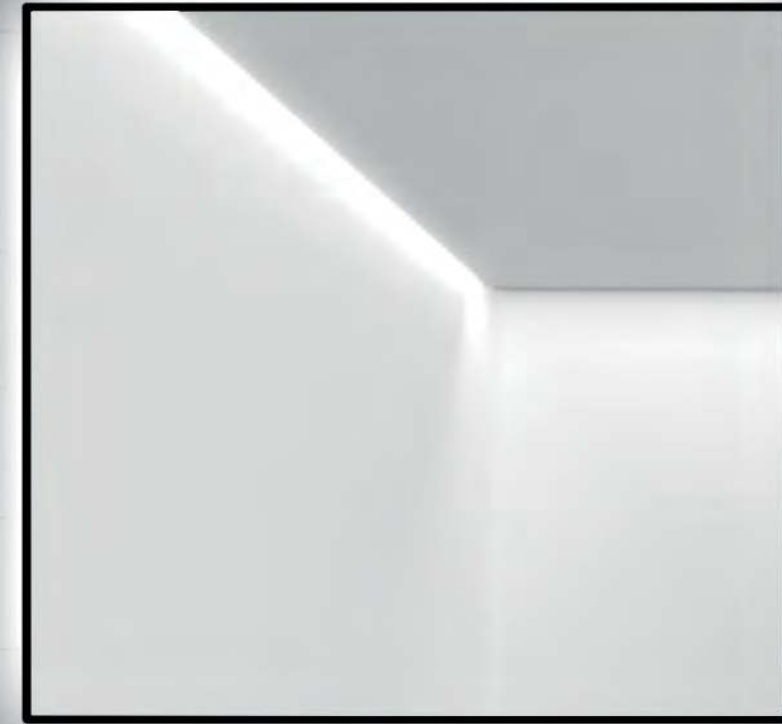
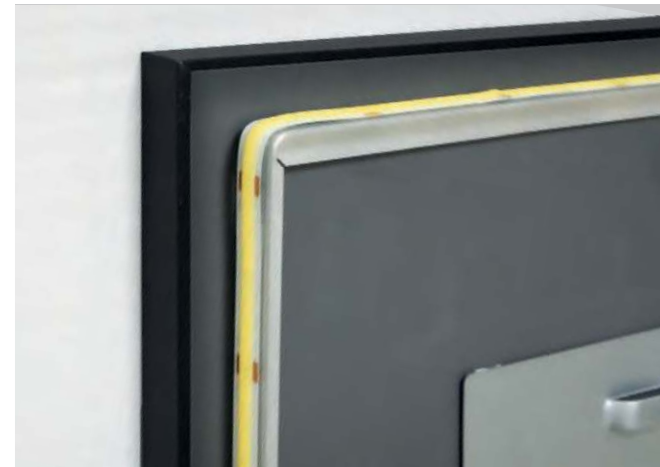

\* Espejo Foto / Photo Mirror: Zoe Rectangular LED 80x80 cm / 5500°k

# Noa Redondo Led

| CM  | W LED | LUMENS | W ANTIVAHU/Opción<br>W DEFOGGER/Optional |
|-----|-------|--------|--|
| Ø60 | 18.20 | 1896   | 16                                       |
| Ø80 | 21.40 | 2229   | 30                                       |



Marco metálico acabado negro / Metallic frame black finish

Opciones / Options :

|  |  |  |  |
|--|--|--|--|
|  |  |  |  |
|  |  |  |  |
|  |  |  |  |

Ficha técnica / Technical sheet :

|  |  |            |  |  |
|--|--|------------|--|--|
|  |  | <b>12V</b> |  |  |
|  |  |            |  |  |

Montaje 17 / Construction 17



\* Espejo Foto / Photo Mirror: Zoe Redondo LED Ø60 cm / 5500°k

# Noa Rectangular Led

| CM     | W LED | LUMENS | W ANTIVAHÓ/Opción<br>W DEFOGGER/Optional |
|--------|-------|--------|--|
| 60x80  | 26.40 | 2750   | 16                                       |
| 80x80  | 30.40 | 3167   | 30                                       |
| 100x80 | 34.40 | 3584   | 46                                       |
| 120x80 | 38.40 | 4001   | 70                                       |
| 140x80 | 42.40 | 4418   | 70                                       |



Producto disponible a medida  
Measures available on request

Opciones / Options :

|  |  |  |  |
|--|--|--|--|
|  |  |  |  |
|  |  |  |  |
|  |  |  |  |

Ficha técnica / Technical sheet :

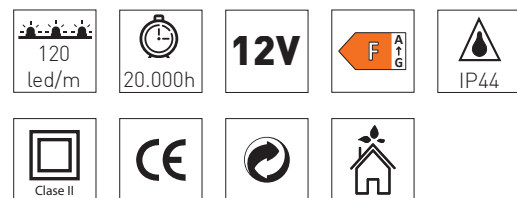

Marco metálico acabado negro / Metallic frame black finish

Montaje 17 / Construction 17



\* Espejo Foto / Photo Mirror: Noa Rectangular Led 80x80 cm / 5500°k

# Klara Redondo

| CM  | W LED | LUMENS |
|-----|-------|--------|
| Ø60 | 26.00 | 1350   |
| Ø80 | 46.00 | 1950   |



Marco metálico acabado negro / Metallic frame black finish

Incluido / Including :

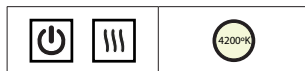

Ficha técnica / Technical sheet :



Foto detalle trasera / Backside view



\* Espejo Foto / Photo Mirror: Klara Led Redondo Ø60 cm / 4200°k   

# Klara Rectangular

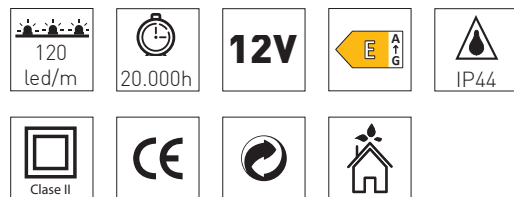
| CM     | W LED | LUMENS |
|--------|-------|--------|
| 80X80  | 60.00 | 2400   |
| 100X80 | 73.00 | 2850   |

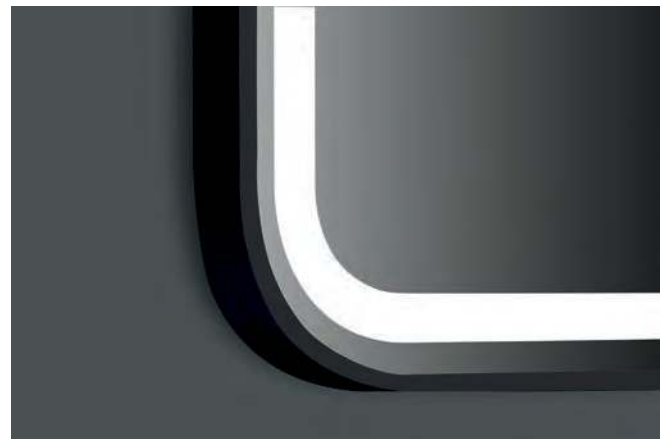

Marco metálico acabado negro / Metallic frame black finish

Incluido / Including :



Ficha técnica / Technical sheet :







Foto detalle trasera / Backside view

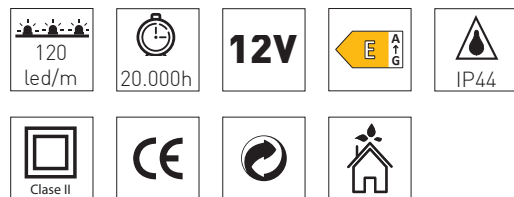

\* Espejo Foto / Photo Mirror: Klara Led Cuadrado 80x80 cm / 4200°k   

# Klara Cápsula

| CM    | W LED | LUMENS |
|-------|-------|--------|
| 50X80 | 34.00 | 1600   |



Marco metálico acabado negro / Metallic frame black finish

Incluido / Including :

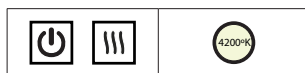

Ficha técnica / Technical sheet :



Foto detalle trasera / Backside view



\* Espejo Foto / Photo Mirror: Klara Led Cápsula 50x80 cm / 4200°k   

# Beth Redondo

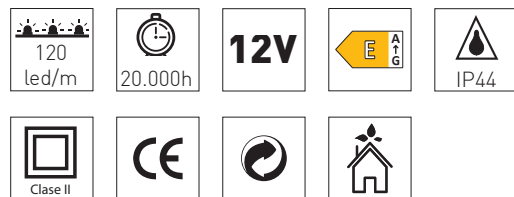
| CM  | W LED | LUMENS |
|-----|-------|--------|
| Ø60 | 11.00 | 1450   |
| Ø80 | 20.00 | 2400   |

Incluido / Including :



Ficha técnica / Technical sheet :



Foto detalle / View detail



Foto detalle trasera / Backside view

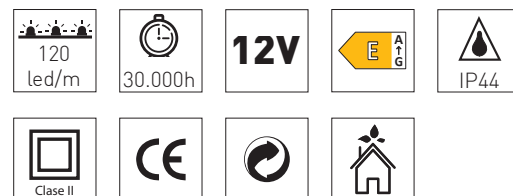

\* Espejo Foto / Photo Mirror: Beth Redondo Ø60 cm / 3000-4000-6500 °k



# Beth Marco Redondo

Medidas / Measures CM

Marco Redondo Ø60 / Ø80 cm  
(Negro/Blanco/Cromo/Oro)  
Round frame Ø60 / Ø80 cm  
(Black/White/Chrome/Gold)

Cinturón (solo negro)  
Belt (only black)

Colgador (Solo Negro)  
Hanging (Only Black)



Acabados marco negro/blanco/cromo/oro  
Black/white/chrome/gold frame finishes

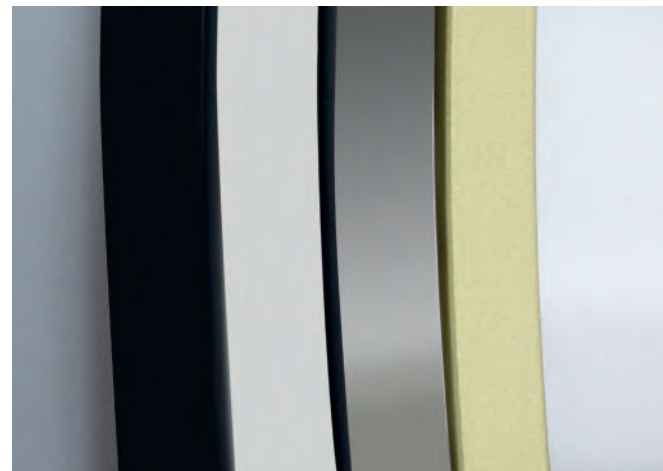

# Beth Rectangular

| CM    | W LED | LUMENS |
|-------|-------|--------|
| 60x80 | 24    | 3150   |

Incluido / Including :



Ficha técnica / Technical sheet :



Foto detalle / View detail

Foto detalle trasera / Backside view

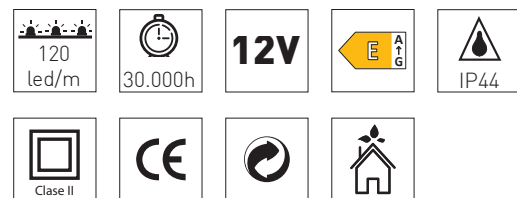

\* Espejo Foto / Photo Mirror: Beth Rectangular 60x80 cm / 3000-4000-6500°k

# Urano

| CM | W LED | LUMENS | W ANTIVAH/Opción<br>W DEFOGGER/Optional |
|----|-------|--------|---|
| 60 | 17.60 | 1833   | 16                                      |
| 80 | 23.90 | 2490   | 30                                      |

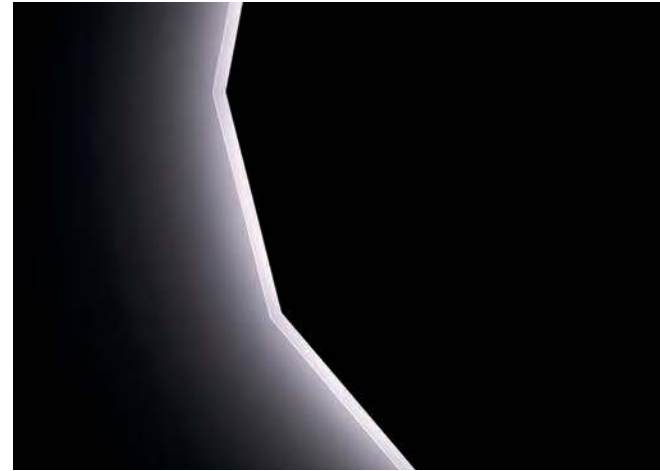

Opciones / Options :

|  |  |  |  |
|--|--|--|--|
|  |  |  |  |
|  |  |  |  |
|  |  |  |  |

Ficha técnica / Technical sheet :

|  |  |  |  |  |
|--|--|--|--|--|
|  |  |  |  |  |
|  |  |  |  |  |

Montaje 13 / Construction 13

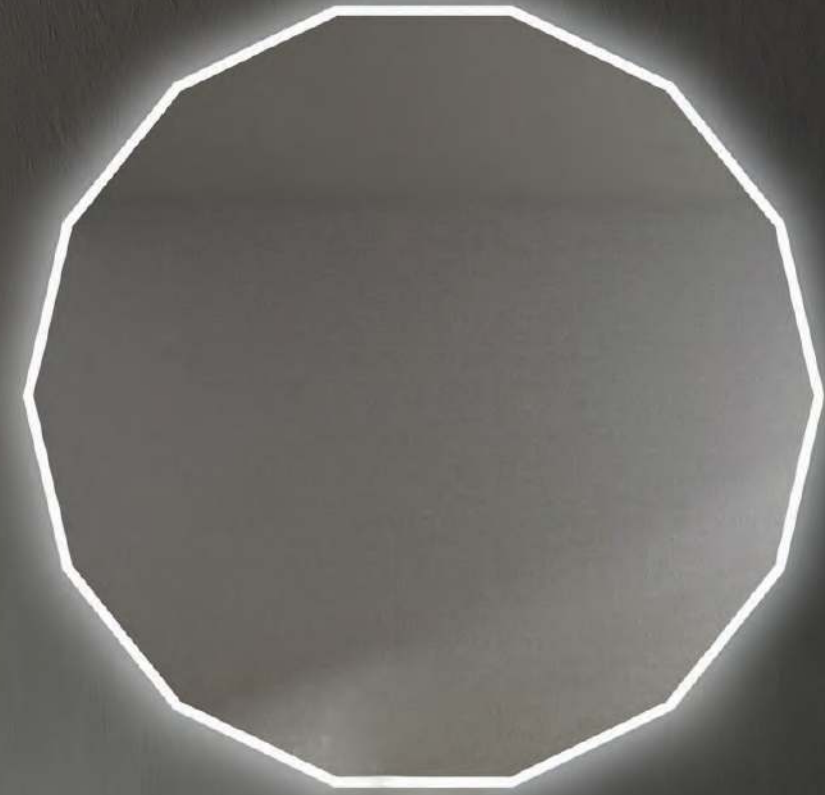

\* Espejo Foto / Photo Mirror: Urano 80 cm / 5500°k

# Iris

| CM  | W LED | LUMENS | W ANTIVAHÓ/Opción<br>W DEFOGGER/Optional |
|-----|-------|--------|--|
| Ø60 | 11.84 | 1110   | 16                                       |
| Ø80 | 16.80 | 1575   | 30                                       |



## Opciones / Options :

|  |  |  |  |
|--|--|--|--|
|  |  |  |  |
|  |  |  |  |
|  |  |  |  |

## Ficha técnica / Technical sheet :

|  |  |            |  |  |
|--|--|------------|--|--|
|  |  | <b>12V</b> |  |  |
|  |  |            |  |  |

Montaje 4 / Construction 4



\* Espejo Foto / Photo Mirror: Iris Ø80 cm / 5500°k

# Lumix

| CM  | W LED | LUMENS | W ANTIVAH/Opción<br>W DEFOGGER/Optional |
|-----|-------|--------|---|
| Ø60 | 15.70 | 1635   | 16                                      |
| Ø70 | 18.80 | 1958   | 16                                      |
| Ø80 | 22.00 | 2292   | 30                                      |
| Ø90 | 25.10 | 2615   | 46                                      |



## Opciones / Options :

|  |  |  |  |
|--|--|--|--|
|  |  |  |  |
|  |  |  |  |
|  |  |  |  |

## Ficha técnica / Technical sheet :

|  |  |  |  |  |
|--|--|--|--|--|
|  |  |  |  |  |
|  |  |  |  |  |

## Montaje 5 / Construction 5

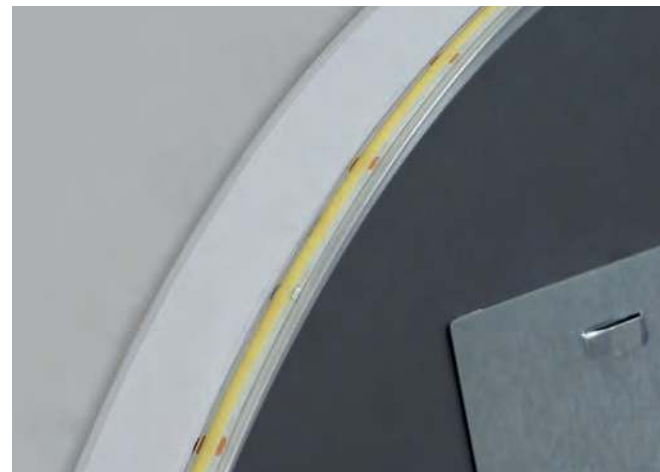

\* Espejo Foto / Photo Mirror: Lumix Ø70 cm / 5500°k

# Duved

| CM   | W LED | LUMENS | W ANTIVAHU/Opción<br>W DEFOGGER/Optional |
|------|-------|--------|--|
| Ø60  | 16.70 | 1740   | 16                                       |
| Ø80  | 22.70 | 2365   | 30                                       |
| Ø100 | 28.10 | 2928   | 46                                       |



Opciones / Options :

|  |  |  |  |
|--|--|--|--|
|  |  |  |  |
|  |  |  |  |
|  |  |  |  |

Ficha técnica / Technical sheet :

|  |  |  |  |  |
|--|--|--|--|--|
|  |  |  |  |  |
|  |  |  |  |  |

Montaje 13 / Construction 13











\* Espejo Foto / Photo Mirror: Duved Ø80 cm / 5500°k

# Stone

| CM    | W LED | LUMENS | W ANTIVAHÓ/Opción<br>W DEFOGGER/Optional |
|-------|-------|--------|--|
| 80X70 | 21.00 | 2188   | 16                                       |

Opciones / Options :

|   |   |   |   |
|---|---|---|---|
|  |  |  |  |
|  |  |  |  |

Ficha técnica / Technical sheet :

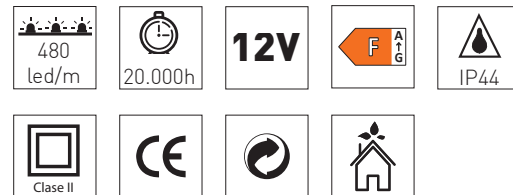

Montaje 15 / Construction 15



\* Espejo Foto / Photo Mirror: Stone 80X70 cm / 5500°k

# Cies Up&Down

| CM     | W LED | LUMENS | W ANTIVAH/Opción<br>W DEFOGGER/Optional |
|--------|-------|--------|---|
| 60x80  | 9.60  | 900    | 16                                      |
| 80x80  | 12.80 | 1200   | 30                                      |
| 100x80 | 16.00 | 1500   | 46                                      |
| 120x80 | 19.20 | 1800   | 70                                      |
| 140x80 | 22.40 | 2100   | 70                                      |



Opciones / Options :

|  |  |  |  |
|--|--|--|--|
|  |  |  |  |
|  |  |  |  |
|  |  |  |  |

Ficha técnica / Technical sheet :

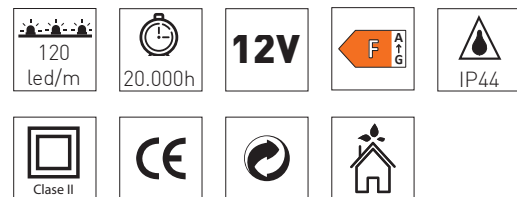

Montaje 8 / Construction 8



\* Espejo Foto / Photo Mirror: Cies Up&Down 100X70 cm / 5500°k



# Nuria

| CM     | W LED | LUMENS | W ANTIVAH/Opción<br>W DEFOGGER/Optional |
|--------|-------|--------|---|
| 60x80  | 3.68  | 345    | 16                                      |
| 80x80  | 5.28  | 495    | 30                                      |
| 100x80 | 6.88  | 645    | 46                                      |
| 120x80 | 8.48  | 795    | 70                                      |
| 140x80 | 10.08 | 945    | 70                                      |



Producto disponible a medida  
Measures available on request

Opciones / Options :

|  |  |  |  |
|--|--|--|--|
|  |  |  |  |
|  |  |  |  |
|  |  |  |  |

Ficha técnica / Technical sheet :

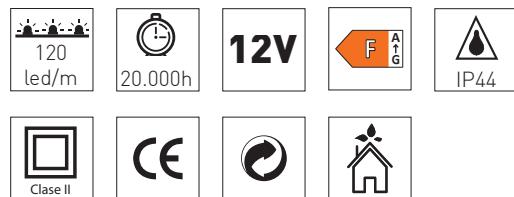

Montaje 19 / Construction 19



\* Espejo Foto / Photo Mirror: Nuria 80X80 cm / 5500%

# Eco One Led con sensor touch

| CM    | W LED | LUMENS | W ANTIVAHU/Opción<br>W DEFOGGER/Optional |
|-------|-------|--------|--|
| 60x80 | 5     | 450    | 16                                       |
| 80x80 | 7     | 630    | 30                                       |



Incluido / Including :



Montaje 6 / Construction 6



Ficha técnica / Technical sheet :

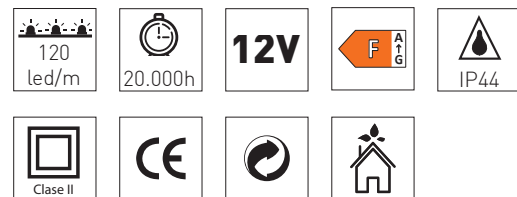

\* Espejo Foto / Photo Mirror: Eco One Led 80X80 cm / 5500°k 

# Eco Two Led

| CM     | W LED | LUMENS | W ANTIVAHU/Opción<br>W DEFOGGER/Optional |
|--------|-------|--------|--|
| 60x80  | 11.36 | 1065   | 16                                       |
| 80x80  | 11.36 | 1065   | 30                                       |
| 100x80 | 11.36 | 1065   | 46                                       |
| 120x80 | 11.36 | 1065   | 70                                       |
| 140x80 | 11.36 | 1065   | 70                                       |



Producto disponible a medida  
Measures available on request

Opciones / Options :

|  |  |  |  |
|--|--|--|--|
|  |  |  |  |
|  |  |  |  |
|  |  |  |  |

Ficha técnica / Technical sheet :

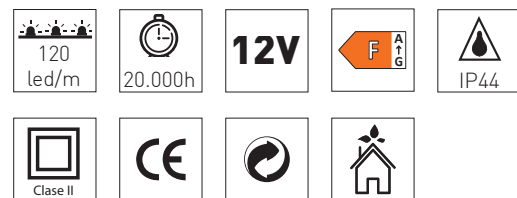

Montaje 10 / Construction 10



\* Espejo Foto / Photo Mirror: Eco Two Led 80X80 cm / 5500°k

# Daphne

| CM     | W LED | LUMENS | W ANTIVAH/Opción<br>W DEFOGGER/Optional |
|--------|-------|--------|---|
| 60X80  | 12.80 | 1200   | 16                                      |
| 80X80  | 12.80 | 1200   | 30                                      |
| 100X80 | 12.80 | 1200   | 46                                      |
| 120X80 | 12.80 | 1200   | 70                                      |



Producto disponible a medida  
Measures available on request

Opciones / Options :

|  |  |  |  |
|--|--|--|--|
|  |  |  |  |
|  |  |  |  |
|  |  |  |  |
|  |  |  |  |

Ficha técnica / Technical sheet :

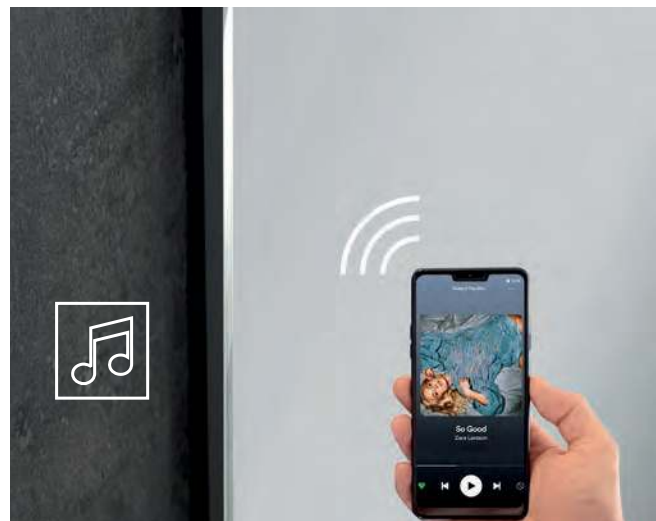
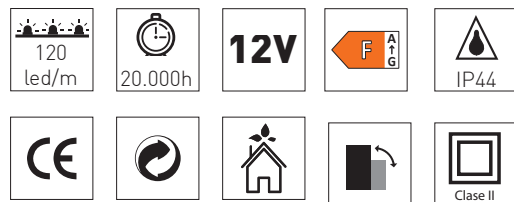

Sistema bluetooth OPCIONAL / OPTIONAL Bluetooth system

Montaje 1 / Construction 1



\* Espejo Foto / Photo Mirror: Daphne 80x80 cm / 5500°K

# Alba

| CM    | W LED | LUMENS | W ANTIVAHÓ/Opción<br>W DEFOGGER/Optional |
|-------|-------|--------|--|
| 60X80 | 4.8   | 480    | 16                                       |

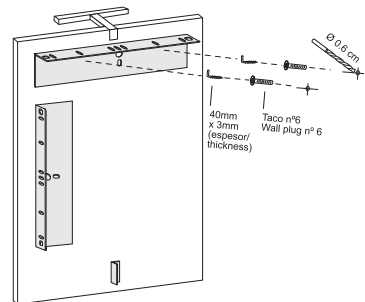

Ficha técnica / Technical sheet :

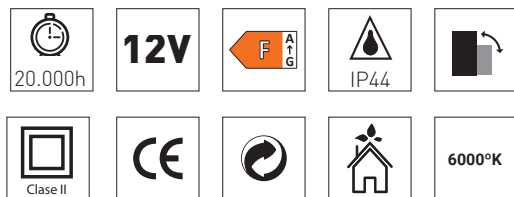

Acabado cromo / Chrome finish



Acabado negro / Black finish

\* Espejo Foto / Photo Mirror: Alba 60x80 cm / 6000°k

# Lua

| CM    | W LED | LUMENS | W ANTIVAH/Opción<br>W DEFOGGER/Optional |
|-------|-------|--------|---|
| 60x80 | 9     | 1000   | 16                                      |
| 80x80 | 15    | 1500   | 30                                      |



Ficha técnica / Technical sheet :

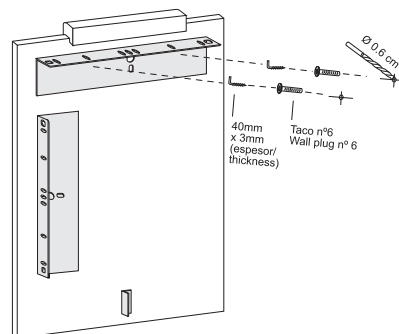

\* Espejo Foto / Photo Mirror: Lua 60x80 cm / 6500°k

# Black

| CM    | W LED | LUMENS | W ANTIVAHU/Opción<br>W DEFOGGER/Optional |
|-------|-------|--------|--|
| 60X80 | 4.8   | 480    | 16                                       |



Balda metálica acabado negro / Metallic shelf black finish

## Ficha técnica / Technical sheet :

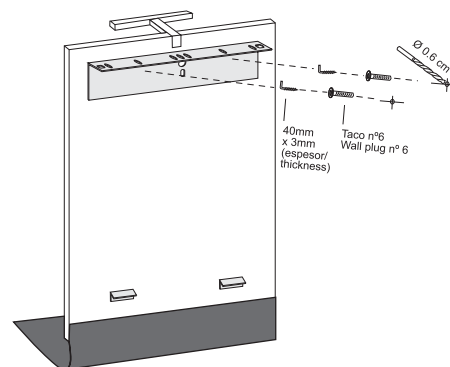
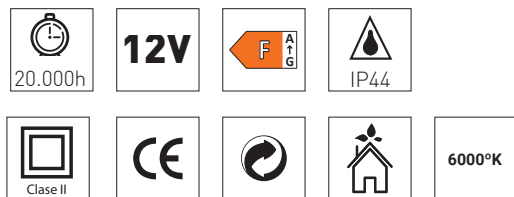

\* Espejo Foto / Photo Mirror: Black 60x80 cm / 6000°k

# Noir

| CM    | W LED | LUMENS | W ANTIVAHÓ/Opción<br>W DEFOGGER/Optional |
|-------|-------|--------|--|
| 60X80 | 5     | 450    | 16                                       |



Balda metálica acabado negro / Metallic shelf black finish

## Ficha técnica / Technical sheet :

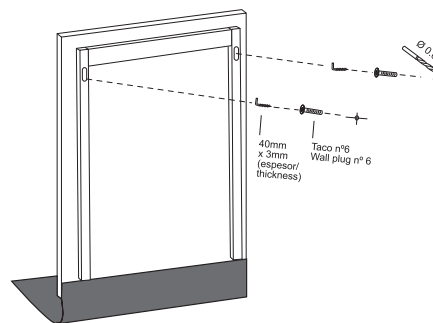
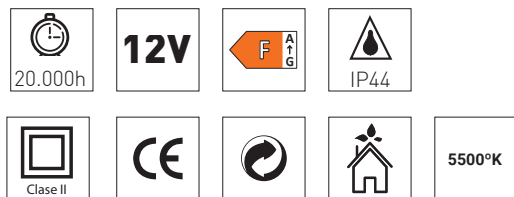

\* Espejo Foto / Photo Mirror: Noir 60x80 cm / 5500°k



# Moncada

CM

60X75

Repisa cristal y soportes incluidos / Glass shelf and supports included



Ficha técnica / Technical sheet :



E14

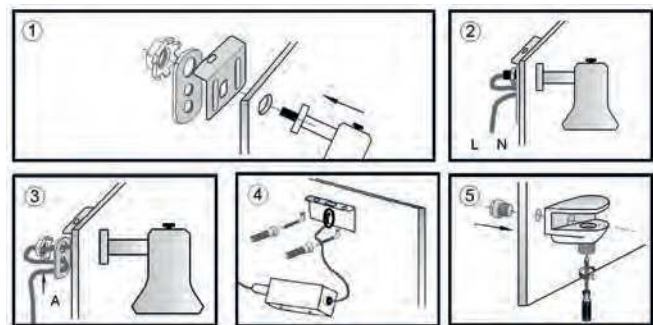

\* Espejo Foto / Photo Mirror: Moncada 60x75 cm

# Valencia

CM

60X75

Repisa cristal y soportes incluidos / Glass shelf and supports included

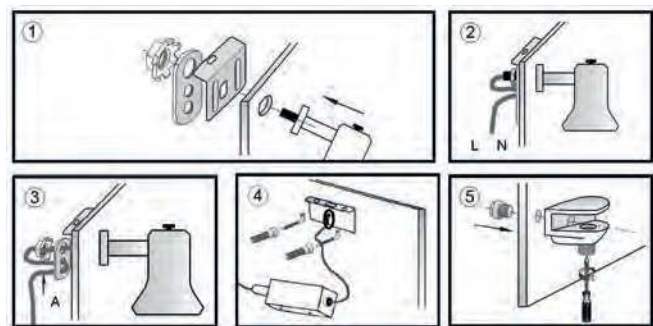

Ficha técnica / Technical sheet :



Clase II



IP23

E14



\* Espejo Foto / Photo Mirror: Valencia 60x75 cm

# Basic

| CM     | W ANTIVAHU/Opción<br>W DEFOGGER/Optional |
|--------|--|
| 50x70  | 16                                       |
| 60x80  | 30                                       |
| 70x80  | 30                                       |
| 80x80  | 46                                       |
| 100x80 | 46                                       |
| 120x80 | 70                                       |
| 140x80 | 70                                       |

Opciones / Options :



Producto disponible a medida  
Measures available on request

Opciones / Options :



Ficha técnica / Technical sheet :

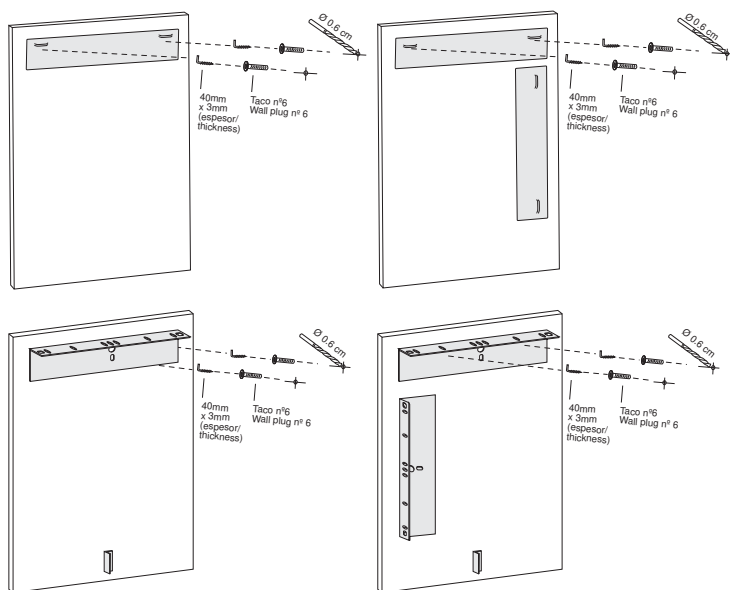

\* Espejo Foto / Photo Mirror: Basic 120x80 cm

# Redondo

| Ø CM | 46W ANTIVAHO/Opción<br>W70 DEFOGGER/<br>Optional |
|------|--|
| 60   | 16   |
| 70   | 30   |
| 80   | 30   |
| 90   | 46   |
| 100  | 46   |
| 120  | 70   |



Opciones / Options :



Ficha técnica / Technical sheet :

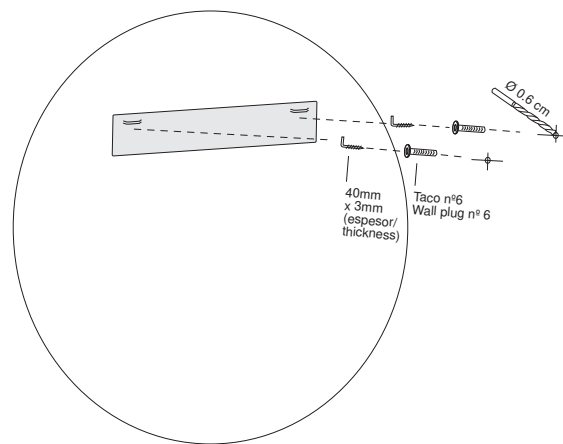

\* Espejo Foto / Photo Mirror: Basic Redondo 80Ø cm

# Cápsula

|       |  |
|-------|--|
| CM    | W ANTIVAHU/Opción<br>W DEFOGGER/Optional |
| 45X90 | 16                                       |



Opciones / Options :



Ficha técnica / Technical sheet :

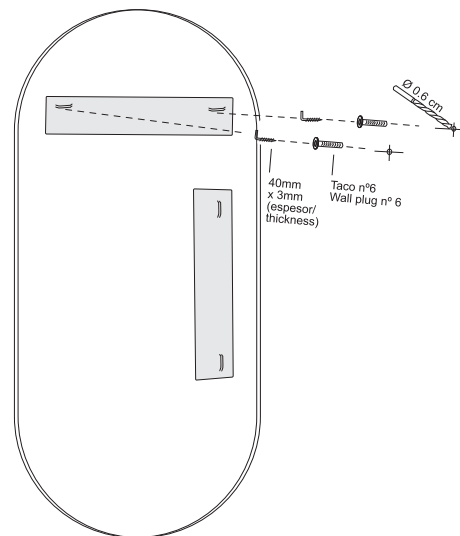

\* Espejo Foto / Photo Mirror: Cápsula 45x90 cm / 5500°k

# Belice

| CM     | W ANTIVAHU/Opción<br>W DEFOGGER/Optional |
|--------|--|
| 60x80  | 16                                       |
| 80x80  | 30                                       |
| 100x80 | 46                                       |
| 120x80 | 70                                       |
| 140x80 | 70                                       |

Opciones / Options :



Ficha técnica / Technical sheet :

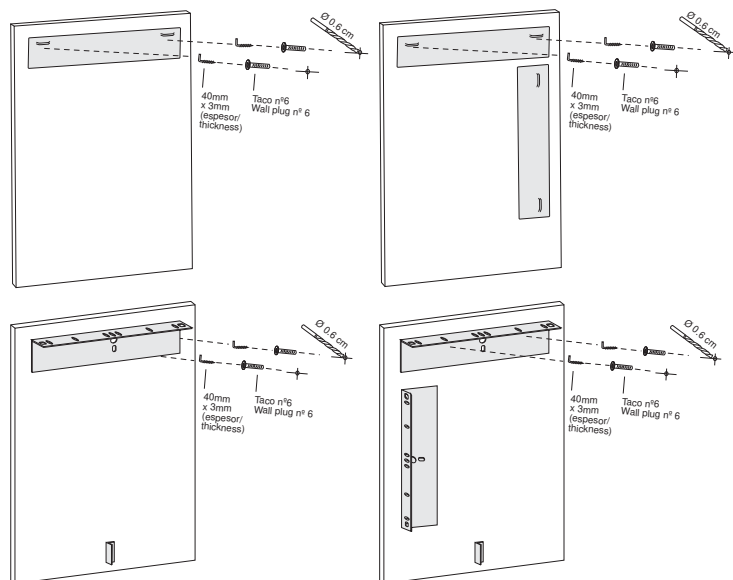

\* Espejo Foto / Photo Mirror: Belice 80x80 cm

# Menorca

| CM     | W ANTIVAHU/Opción<br>W DEFOGGER/Optional |
|--------|--|
| 50x70  | 16                                       |
| 60x80  | 30                                       |
| 70x80  | 30                                       |
| 80x80  | 46                                       |
| 100x80 | 46                                       |
| 120x80 | 70                                       |
| 140x80 | 70                                       |



Producto disponible a medida  
Measures available on request

Opciones / Options :



Ficha técnica / Technical sheet :

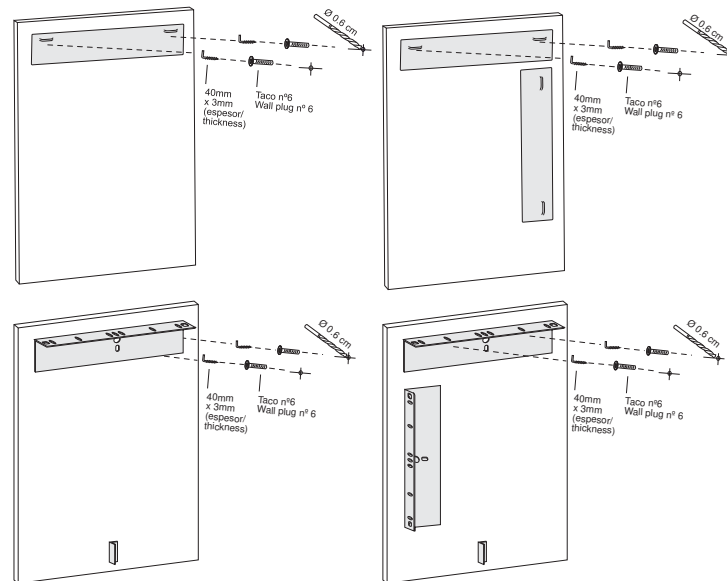

\* Espejo Foto / Photo Mirror: Menorca 100x80 cm

# Romo

| CM     | W ANTIVAHÓ/Opción<br>W DEFOGGER/Optional |
|--------|--|
| 50x70  | 16                                       |
| 60x80  | 30                                       |
| 70x80  | 30                                       |
| 80x80  | 46                                       |
| 100x80 | 46                                       |
| 120x80 | 70                                       |
| 140x80 | 70                                       |



Producto disponible a medida  
Measures available on request

Opciones / Options :



Ficha técnica / Technical sheet :

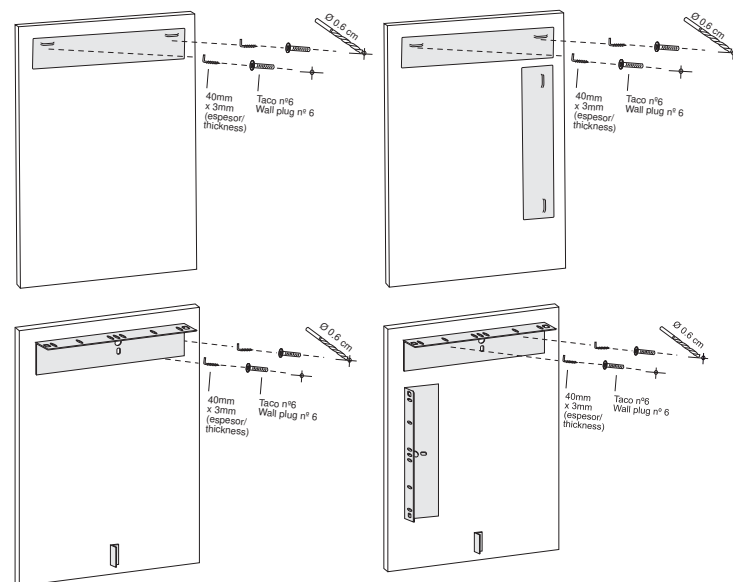

\* Espejo Foto / Photo Mirror: Romo 80x80 cm



# Mireia Canto Pulido

| CM    | W ANTIVAH0/Opción<br>W DEFOGGER/Optional |
|-------|--|
| 45X90 | 16                                       |



Opciones / Options :



Ficha técnica / Technical sheet :

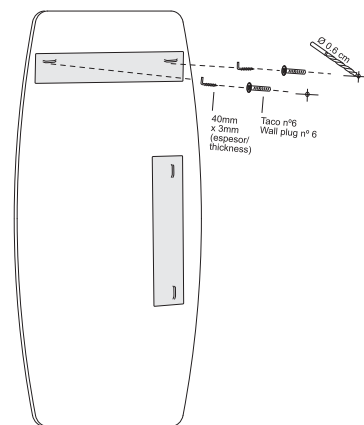

\* Espejo Foto / Photo Mirror: Mireia 45x90 cm

# Jaspe Canto Pulido

| CM    | W ANTIVAH0/Opción<br>W DEFOGGER/Optional |
|-------|--|
| 40x80 | 16                                       |



Opciones / Options :



Ficha técnica / Technical sheet :

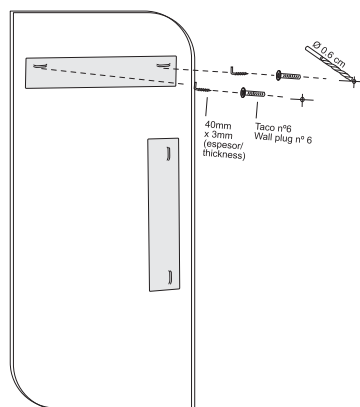

\* Espejo Foto / Photo Mirror: Jaspe 45x80 cm

# Altair Aplique

| CM | WATIOS LED | LUMENS |
|----|------------|--------|
| 30 | 5.4        | 540    |
| 50 | 7          | 600    |

Ficha técnica / Technical sheet :

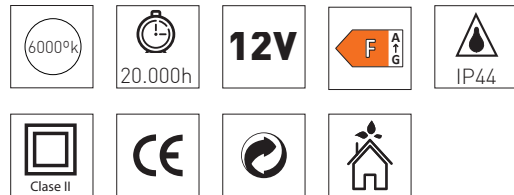

Doble sistema de fijación / Dual fixation system

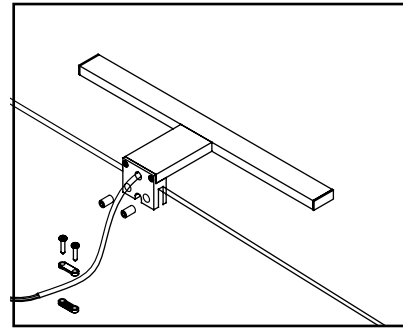

Espejo  
Mirror

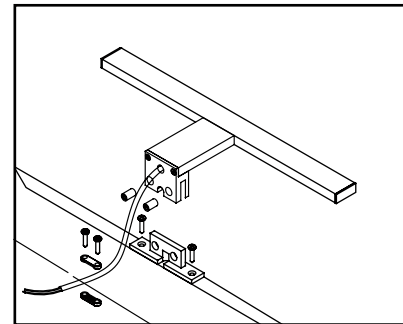

Marco madera  
Wood frame

ALTAIR 30 cm

Acabados / Finishes:  
Cromo / Chrome  
Negro / Black



ALTAIR 50 cm

Acabados / Finishes:  
Cromo / Chrome  
Negro / Black

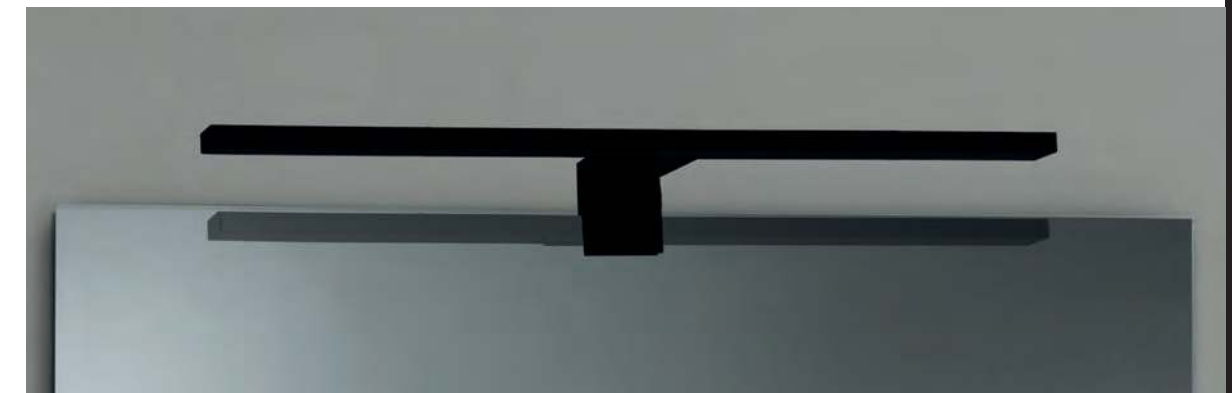

# Drop Aplique

| CM | WATIOS LED | LUMENS |
|----|------------|--------|
| 30 | 7          | 600    |
| 45 | 7          | 650    |
| 60 | 14         | 1300   |

Doble sistema de fijación / Dual fixation system

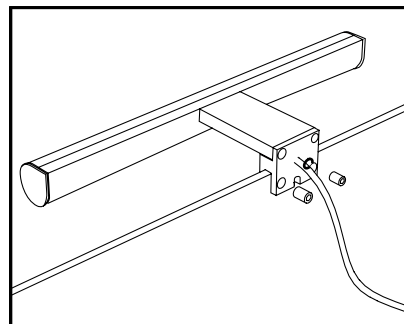

Espejo  
Mirror

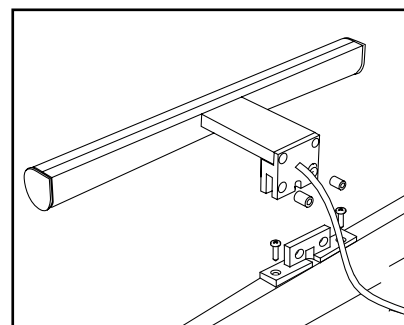

Marco madera  
Wood frame

DROP 30 cm

Acabados / Finishes:  
Cromo / Chrome



DROP 45 cm

Acabados / Finishes:  
Cromo / Chrome



DROP 60 cm

Acabados / Finishes:  
Cromo / Chrome



Ficha técnica / Technical sheet :

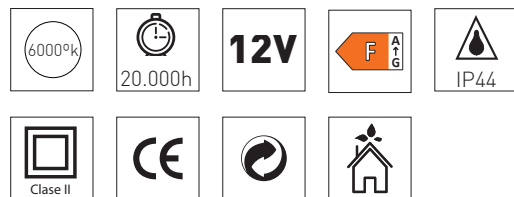

# Round Aplique

| CM | WATIOS LED | LUMENS |
|----|------------|--------|
| 30 | 7          | 600    |
| 45 | 7          | 650    |
| 60 | 14         | 1300   |

Doble sistema de fijación / *Dual fixation system*

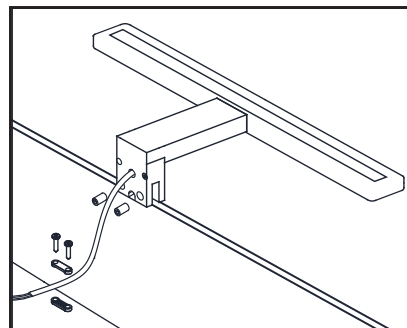

Espejo  
*Mirror*

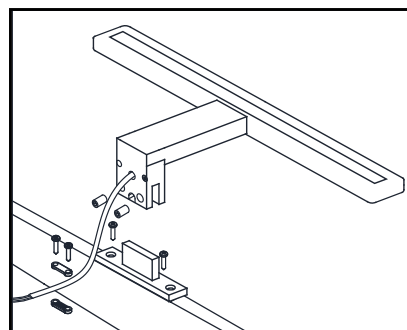

Marco madera  
*Wood frame*

ROUND 30 cm

Acabados / *Finishes:*  
Cromo / *Chrome*



ROUND 45 cm

Acabados / *Finishes:*  
Cromo / *Chrome*



ROUND 60 cm

Acabados / *Finishes:*  
Cromo / *Chrome*



Ficha técnica / *Technical sheet :*

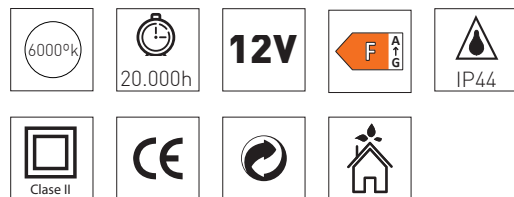

xpertials  
home







ILUMINAMOS TU **HOGAR**  
WE BRING LIGHTING MOODS  
TO YOUR **HOME**



# Aitana home

| CM     | W LED | LUMENS |
|--------|-------|--------|
| 50x150 | 31.96 | 2940   |

Opciones / Options :

|   |   |   |
|---|---|---|
|  |  |  |
|  |  |  |

Ficha técnica / Technical sheet :

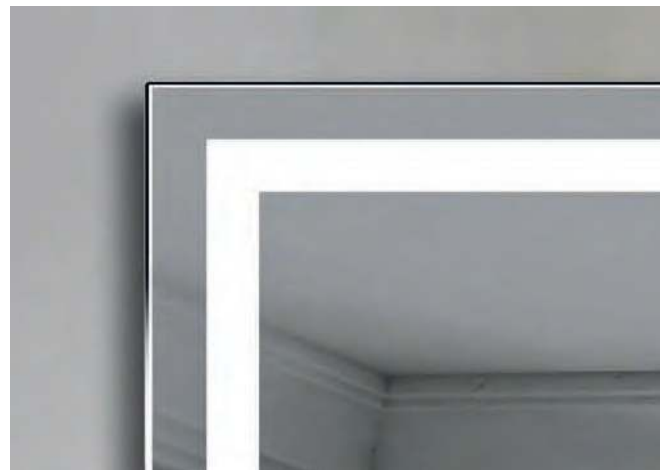
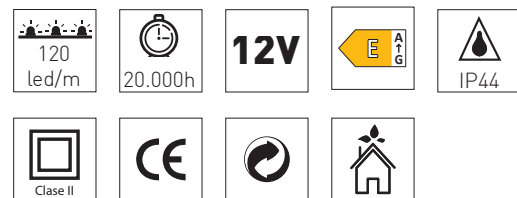

Montaje 9 / Construction 9



\* Espejo Foto / Photo Mirror: Aitana Home 50x150 cm / 4200°k

# Shira home

| CM     | W LED | LUMENS |
|--------|-------|--------|
| 50x150 | 30.72 | 2880   |



Opciones / Options :

|  |  |  |
|--|--|--|
|  |  |  |
|  |  |  |

Ficha técnica / Technical sheet :

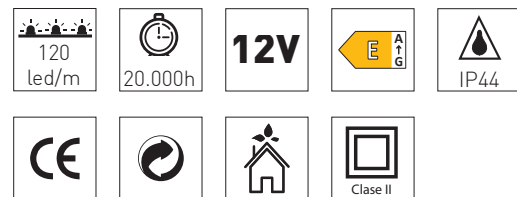

Montaje 2 / Construction 2









\* Espejo Foto / Photo Mirror: Shira Home 50x150 cm / 4200°k











# Anaïs home

| CM     | W LED | LUMENS |
|--------|-------|--------|
| 50x150 | 29.44 | 2760   |

Opciones / Options :

|   |   |   |
|---|---|---|
|  |  |  |
|  |  |  |

Ficha técnica / Technical sheet :

|  |  |   |   |   |
|--|--|---|---|---|
| <br>120<br>led/m | <br>20.000h | <b>12V</b>  |  | <br>IP44 |
| <br>Clase II     |             |  |  |   |



Acabado acero / Steel finish



Acabado negro / Black finish

Montaje 1 / Construction 1



\* Espejo Foto / Photo Mirror: Anaïs Home 50x150 cm / 4200°k 

## TIPOS DE MONTAJE / CONSTRUCTION TYPE

MONTAJE 1 / CONSTRUCTION 1



Marco PVC canto acero o negro / Pvc Frame Steel or Black Edge

MONTAJE 2 / CONSTRUCTION 2



Marco PVC con tira led incrustada / Pvc frame with integrated led strip

MONTAJE 3 / CONSTRUCTION 3



Marco perfil aluminio disipador - tira cobled luz continua / Aluminium heatsink profile frame - cobled led strip-continous light.

MONTAJE 7 / CONSTRUCTION 7



Perfil PVC con colgador - tira cobled luz continua/ Pvc profile with hanger - cobled led strip-continous light

MONTAJE 8 / CONSTRUCTION 8



Marco perfil aluminio / Aluminium profile frame

MONTAJE 9 / CONSTRUCTION 9



Marco de PVC retranqueado / PVC frame fully trucked

MONTAJE 4 / CONSTRUCTION 4



Marco PVC con tira led / Pvc frame with led strip

MONTAJE 5 / CONSTRUCTION 5



Marco perfil aluminio disipador - tira cobled luz continua / Aluminium heatsink profile frame - cobled led strip-continous light

MONTAJE 6 / CONSTRUCTION 6



Marco mixto pvc + alumminio / PVC + aluminium frame.

MONTAJE 10 / CONSTRUCTION 10



Marco PVC / PVC frame

MONTAJE 11 / CONSTRUCTION 11



Marco perfil aluminio / Aluminium profile frame

MONTAJE 12 / CONSTRUCTION 12



Marco mixto PVC / PVC mixed frame

## TIPOS DE MONTAJE / CONSTRUCTION TYPE

MONTAJE 13 / CONSTRUCTION 13



Goma espuma gris - tira cobled luz continua / Grey foam gum - cobled strip-continous light.

MONTAJE 14 / CONSTRUCTION 14



Marco perfil aluminio disipador - tira cobled luz continua / Aluminium heatsink profile frame - cobled led strip-continous light.

MONTAJE 15 / CONSTRUCTION 15



Goma espuma gris - tira cobled luz continua / Grey foam gum - cobled strip-continous light.

MONTAJE 19 / CONSTRUCTION 19



Perfil PVC + Aluminio / PVC profile + aluminium.

MONTAJE 16 / CONSTRUCTION 16



Marco perfil aluminio disipador - tira cobled luz continua / Aluminium heatsink profile frame - cobled led strip-continous light.

MONTAJE 17 / CONSTRUCTION 17



Marco perfil aluminio / Aluminium profile frame.

MONTAJE 18 / CONSTRUCTION 18



Marco PVC con tira led incrustable / PVC frame wit integrated led strip.

## SISTEMAS ANCLAJE A PARED / WALL FIXATION SYSTEM

Anclaje a pared para perfil de PVC / Mirror fixation to the wall on PVC profiles.



Anclaje a pared con un colgador plano / Mirror fixation to the wall on a flat metal hanger.



Anclaje a pared con un colgador tipo "L" / Mirror fixation to the wall on an "L" type metal hanger.

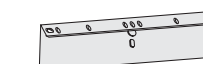

## LEYENDA ICONOGRAFÍA / KEY TO SYMBOLS



### SENSOR LED

Aumenta y disminuye la intensidad luz, se coloca en luna.  
*LED SENSOR*

*Placed on the glass. It increases and decreases the intensity of the light.*



### SENSOR LATERAL

Táctil Cromo enciende y apaga la luz, aumenta y disminuye la intensidad de la luz, se coloca en el perfil no todos los modelos lo permiten.

#### *LATERAL SENSOR*

*Chrome touch sensor to turn the light on and off, increases and decreases the intensity of the light, it's placed on the profile. Not available on all models.*



### SENSOR ANTIVAHU O LED/ANTIVAHU

Enciende y apaga el antivaho o enciende y apaga todo a la vez, aumenta y disminuye la intensidad de la luz, se coloca en la luna.

#### *DEMISTER SENSOR OR LED/DEMISTER*

*Placed on the glass. It turns the light and defog or both at same time. It increases and decreases the light intensity.*



### SISTEMA ANTIVAHU (Doble sensor on/off led + on/off antivaho)

1 sensor enciende y apaga la luz, aumenta y disminuye la intensidad de la luz + 1 sensor enciende y apaga el antivaho.

#### *DEMISTER SYSTEM (Double sensor on/off for led light + on/off demister).*

*1 sensor turns on/off the light, increase and decrease the light intensity + 1 sensor turns on/off demister.*



### SENSOR CAMBIO COLOR

ON/OFF LED+DIMMER aumenta y disminuye la intensidad de la luz + CAMBIO DE COLOR LED 3000°k-4200°k-5500°K

#### *CHANGE COLOUR SENSOR*

*On/off led light + dimmer. It increases and decreases the intensity of light + led colour chage 3000°k-4200°k-5500°K*



### SENSOR GESTUAL

Enciende la luz.

#### *GESTURE SENSOR*

*Turns on the light.*



### SISTEMA SCREEN

1 sensor led + 1 sensor pantalla + pantalla - incompatible con el sistema bluetooth.

#### *SCREEN SYSTEM*

*1 led sensor + 1 screen sensor. Screen incompatible with bluetooth system*



### SISTEMA BLUETOOTH PARA ESPEJOS CON LUZ

1 sensor led + 1 sensor bluetooth + altavoz 12v - incompatible con el sistema screen.

#### *BLUETOOTH SYSTEM FOR LIGHTED MIRRORS*

*1 led sensor + 1 bluetooth sensor + speaker 12. Incompatible with screen system.*



### SISTEMA DETECTOR MOVIMIENTO

#### *MOTION DETECTION SYSTEM*



### AUMENTO 5X LED 17 CM

*5X MAGNIFICENT LED MIRROR 17 CM.*



### AUMENTO 5X LED 17 CM SENSOR LED

*5X MAGNIFICENT LED MIRROR 17 CM WITH SENSOR.*



### COLOR TEMPERATURA KELVIN

*KELVIN COLOUR TEMPERATURE*



### COLOR TEMPERATURA KELVIN

*KELVIN COLOUR TEMPERATURE*



### COLOR TEMPERATURA KELVIN

*KELVIN COLOUR TEMPERATURE*

## LEYENDA ICONOGRAFÍA / KEY TO SYMBOLS



Posición horizontal y vertical  
*Vertical and horizontal position*



Bajo consumo  
*Energy saving*



Clase I  
*Class I*



Puntos led por metro  
*Leds per meter*



Voltaje  
*Voltage*



Clase II  
*Class II*



Puntos led por metro  
*Leds per meter*



Durabilidad  
*Durability*



Adheridos a Ecoembes  
*Adherent to Ecoembes (green dot)*



Grado de protección  
*Degree of protection*



Angulo de apertura luz  
*Opening angle of lightning*



Marcado CE  
*CE marking*



Eficiencia energética  
*Energetic efficiency*



Eficiencia energética  
*Energetic efficiency*

## Notas / Notes

-----

-----

-----

-----

-----

-----

-----

-----

-----

-----

-----

-----

-----

-----

-----

-----

-----

-----

-----

**Iluminamos tu baño**

We bring lighting moods to your bathroom

**xpertials**  
baño

# xpertials

baño

C/ DE LA CREUETA, N°20 / CP: 46138 / RAFAELBUNYOL / VALENCIA  
T. +34 96 110 40 40 / F. +34 96 110 23 23 / INFO@XPERTIALS.COM  
WWW.XPERTIALS.COM

